

PREFACE

In the auricular structure introduced by this University for students of Post- Graduate degree programme, the opportunity to pursue Post-Graduate course in Subject introduced by this University is equally available to all learners. Instead of being guided by any presumption about ability level, it would perhaps stand to reason if receptivity of a learner is judged in the course of the learning process. That would be entirely in keeping with the objectives of open education which does not believe in artificial differentiation.

Keeping this in view, study materials of the Post-Graduate level in different subjects are being prepared on the basis of a well laid-out syllabus. The course structure combines the best elements in the approved syllabi of Central and State Universities in respective subjects. It has been so designed as to be upgradable with the addition of new information as well as results of fresh thinking and analysis.

The accepted methodology of distance education has been followed in the preparation of these study materials. Co-operation in every form of experienced scholars is indispensable for a work of this kind. We, therefore, owe an enormous debt of gratitude to everyone whose tireless efforts went into the writing, editing and devising of a proper lay-out of the materials. Practically speaking, their role amounts to an involvement in invisible teaching. For, whoever makes use of these study materials would virtually derive the benefit of learning under their collective care without each being seen by the other.

The more a learner would seriously pursue these study materials the easier it will be for him or her to reach out to larger horizons of a subject. Care has also been taken to make the language lucid and presentation attractive so mat they may be rated as quality self-learning materials. If anything remains still obscure or difficult to follow, arrangements are there to come to terms with them through the counselling sessions regularly available at the network of study centres set up by the University.

Needless to add, a great deal of these efforts is still experimental-in fact, pioneering in certain areas. Naturally, there is every possibility of some lapse or deficiency here and there. However, these do admit of rectification and further improvement in due course. On the whole, therefore, these study materials are expected to evoke wider appreciation the more they receive serious attention of all concerned.

Professor (Dr.) Subha Sankar Sarkar
Vice-Chancellor

Sixth Reprint : December, 2017

Printed in accordance with the regulations of the Distance Education
Bureau of the University Grants Commission.

Subject : Mathematics

Post Graduate

Paper : PG (MT) : IX A(I)

: Writer :

Prof. P. K. Sengupta

: Editor :

Prof. B. C. Chakraborty

Notification

All rights reserved. No part of this book may be reproduced in any form without permission in writing from Netaji Subhas Open University.

Mohan Kumar Chottopadhaya
Registrar



**NETAJI SUBHAS
OPEN UNIVERSITY**

PG (MT)–IX A(I)

Unit 1 □ Analytic Continuation	7-25
Unit 2 □ Harmonic Functions	26-40
Unit 3 □ Conformal Mappings	41-49
Unit 4 □ Multi-valued Functions and Riemann Surface	50-82
Unit 5 □ Conformal Equivalence	83-104
Unit 6 □ Entire and Meromorphic Functions	105-155

Unit 1 □ Analytic Continuation

Structure

- 1.0 Objectives of this chapter
- 1.1 The idea of analytic continuation
- 1.2 Direct analytic continuation
- 1.3 Analytic continuation of elementary functions
- 1.4 Analytic continuation by power series
- 1.5 Analytic continuation along a curve
- 1.6 Multi-valued Functions and Analytic continuation

1.0 Objectives of this Chapter

In this chapter we shall introduce the idea of direct analytic continuation of an analytic function. The concepts of analytic continuation by means of power series, complete analytic function, natural boundary, analytic continuation along a curve will be explained with the help of examples. Homotopic curves, analytic continuation of multi-valued function and Monodromy theorem will also be discussed.

1.1 The idea of analytic continuation

The idea of analytic continuation rests on the notion of analytic function. A function $f(z)$ is analytic at $z = z_0$ if it is differentiable in some ϵ -neighbourhood of z_0 or, equivalently if it can be expressed in the form of a Taylor series in a neighbourhood of that point. The domain of convergence of this power series will be the region of analyticity of the function $f(z)$.

Following Uniqueness Theorem : “If two functions $f(z)$ and $g(z)$, analytic on a region D , are such that $f(z) = g(z)$ on a set $A \subset D$ having a limit point in D , then $f(z) = g(z) \forall z \in D$,” we know that if two analytic functions agree in some small neighbourhood of a point situated in their common region of analyticity D , they

coincide everywhere in D . We first introduce the idea of analytic continuation by the following examples.

The geometric series

$$1 + z + z^2 + \dots$$

converges for $|z| < 1$ and its sum function $g(z) = \frac{1}{1-z}$ is an analytic function for $|z| < 1$.

The geometric series diverges for $|z| \geq 1$.

However, the function

$$h(z) = \frac{1}{1-z}$$

is analytic for all z except $z = 1$. But we observe that

$$h(z) = g(z) \quad \forall z \in \{|z| < 1 \cap \mathbb{C} \setminus \{1\}\}$$

Thus, we may regard $h(z)$ as determining an analytic continuation of $g(z)$ from the domain $|z| < 1$ into the domain $\mathbb{C} \setminus \{1\}$.

Example 1.1 Consider the Laplace transform of 1 in the z -plane,

$$F(z) = \mathcal{L}\{1\}(z) = \int_0^{\infty} e^{-zt} dt = \frac{1}{z} \quad \text{for } \operatorname{Re} z > 0$$

We introduce a function

$$\phi(z) = \frac{1}{z}$$

which is analytic in the complex plane \mathbb{C} except the origin. Here

$$\phi(z) = F(z) \quad \forall z \in \mathbb{C} \setminus (0) \cap \operatorname{Re} z > 0$$

and we consider $\phi(z)$ as analytic continuation of $F(z)$ from the domain $\operatorname{Re} z > 0$ into the complex plane with the point $z = 0$ deleted.

We put these ideas more precisely in the following discussion.

1.2 Direct analytic continuation

Let (i) $f(z)$ and $g(z)$ be analytic functions on domains D_1 and D_2 respectively.

(ii) $D_1 \cap D_2 \neq \emptyset$

(iii) $f(z) = g(z)$ for all z belonging to $D_1 \cap D_2$

Then $g(z)$ is called a direct analytic continuation of $f(z)$ to D_2 , and vice versa.

Theorem 1.1. A direct analytic continuation, if it exists, is unique.

Proof. Let $f(z)$ be an analytic function with domain of definition D_1 and let $g(z)$, another analytic function with domain of definition D_2 , be its direct analytic continuation. We shall show that $g(z)$ is unique. On the contrary suppose $\phi(z)$ be another analytic continuation of $f(z)$ into D_2 . Then

$$f(z) = g(z) \text{ for all } z \in D_1 \cap D_2$$

$$\text{Also, } f(z) = \phi(z) \text{ for all } z \in D_1 \cap D_2$$

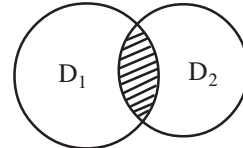

Fig. 1

and so $\phi(z)$ coincides with $g(z)$ in $D_1 \cap D_2$. Thus we have, by the Uniqueness theorem, $\phi(z) = g(z)$ in D_2 .

1.3 Analytic continuation of elementary functions

The functions e^z , $\sin z$, $\cos z$, $\sinh z$ etc are already known to us. These functions are regular in the entire complex plane. Let us assume, by definition, that

$$e^z = \sum_{n=0}^{\infty} \frac{z^n}{n!}$$

and observe that it coincides with e^x , known earlier, for real values of z . Thus we can take e^z as the analytic continuation of e^x from real axis into the entire complex plane. Likewise introducing $\sin z$, $\cos z$, $\sinh z$, $\cosh z$ in the form of power series—

$$\sin z = \sum_{n=0}^{\infty} \frac{(-1)^n z^{2n+1}}{(2n+1)!}, \quad \cos z = \sum_{n=0}^{\infty} \frac{(-1)^n z^{2n}}{(2n)!}$$

$$\sinh z = \sum_{n=0}^{\infty} \frac{z^{2n+1}}{(2n+1)!} \quad \text{and} \quad \cosh z = \sum_{n=0}^{\infty} \frac{z^{2n}}{(2n)!}$$

We can treat them as the analytic continuation of the functions $\sin x$, $\cos x$, $\sinh x$ and $\cosh x$ respectively from the real axis into the entire complex plane.

1.4 Analytic continuation by power series

We now explain the concept of analytic continuation by means of power series.

Suppose the initial function $f_1(z)$ is analytic at a point z_1 . Then $f_1(z)$ can be represented by its Taylor series about z_1 as

$$f_1(z) = \sum_{n=0}^{\infty} a_n (z - z_1)^n \dots (1), \text{ where } a_n = \frac{f_1^{(n)}(z_1)}{n!}$$

The circle of convergence γ_1 of the series (1) is given by

$$\gamma_1: |z - z_1| = R_1, \text{ where}$$

$$\frac{1}{R_1} = \limsup_{n \rightarrow \infty} |a_n|^{\frac{1}{n}}$$

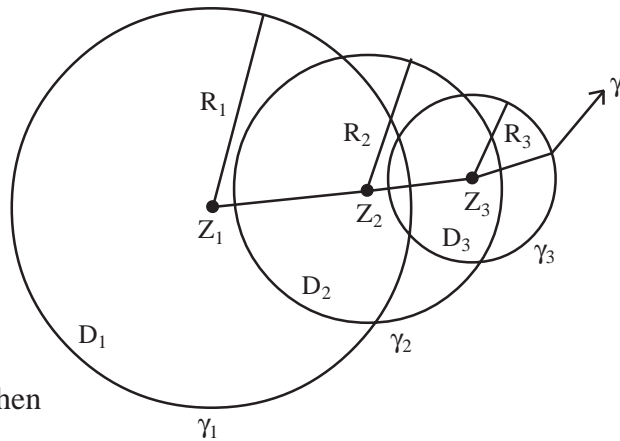

Let $D_1 = \{z : |z - z_1| < R_1\}$. Then

$f_1(z)$ is analytic in D_1 . We draw a curve γ from z_1 and perform analytic continuation along γ as follows :

We take a point z_2 on γ such that the arc $\widehat{z_1 z_2}$ lies inside γ_1 .

We then compute the values $f_1(z_2), f_1'(z_2), \dots, f_1^{(n)}(z_2)$ by successive term by term differentiation of the series (1) and write

$$f_2(z) = \sum_{n=0}^{\infty} b_n (z - z_2)^n \dots (2) \text{ where } b_n = \frac{f_1^{(n)}(z_2)}{n!}$$

The circle of convergence γ_2 of the series (2) is given by

$$\gamma_2: |z - z_2| = R_2, \text{ where } \frac{1}{R_2} = \limsup_{n \rightarrow \infty} |b_n|^{\frac{1}{n}}$$

Let $D_2 = \{z: |z - z_2| < R_2\}$. Then $f_2(z)$ is analytic in D_2 . By uniqueness theorem, $f_1(z) = f_2(z)$ for all $z \in D_1 \cap D_2$. If γ_2 extends beyond γ_1 , then $f_2(z)$ gives an analytic continuation of $f_1(z)$ from D_1 to D_2 . Similarly, considering a point z_3 on γ such that

the arc $\widehat{z_2 z_3}$ lies inside γ_2 , we get an analytic function $f_3(z)$ in a circular domain D_3 such that $f_2(z) = f_3(z)$ for all $z \in D_2 \cap D_3$. If D_3 extends beyond D_2 , then $f_3(z)$ gives an analytic continuation of $f_2(z)$ from D_2 to D_3 . Repeating this process we get a number of different power series representing analytic functions $f_i(z)$ in their respective circular domains D_i which form a chain of analytic continuations of the original function $f_1(z)$ such that (f_i, D_i) is a direct analytic continuation of (f_{i-1}, D_{i-1}) .

Note : We may obtain the series (2) from the series (1) in the following way :

We rewrite the series (1) in the form : $\sum_{n=0}^{\infty} a_n \{(z - z_2) + (z_2 - z_1)\}^n$

Using binomial theorem we then expand $\{(z - z_2) + (z_2 - z_1)\}^n$ and collect the terms in like powers of $(z - z_2)$ and obtain the series (2).

We give two examples.

Example 1.2 The function

$$f(z) = \frac{1}{1+z^2}$$

possesses two simple poles at $z = \pm i$; Otherwise it is regular throughout the whole complex plane. We first choose a point, say $z = 0$ at which $f(z)$ is analytic and obtain its Taylor series expansion represented by $g(z)$ as

$$g(z) = 1 - z^2 + z^4 - \dots, |z| < 1$$

The series fails to converge on and beyond the unit circle, as is clear from the

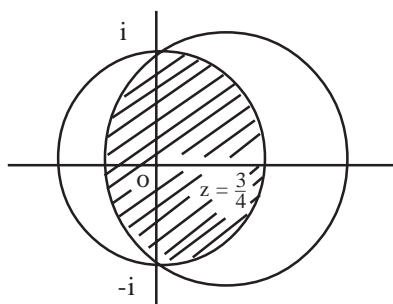

Fig. 2

series for $z = 1$ even though the function $f(z)$ is analytic at that point. We can in fact continue the expansion from one region to another. Let us consider a second expansion of $f(z)$, this time about a point $z = \frac{3}{4}$ lying inside the unit circle (i.e. lying inside the region of convergence of the former series). We form the expansion as follows

$$\frac{1}{1+z^2} = \frac{1}{(z+i)(z-i)} = \frac{1}{2i} \left(\frac{1}{z-i} - \frac{1}{z+i} \right)$$

$$\begin{aligned}
&= \frac{1}{2i} \left\{ \frac{1}{z - \frac{3}{4} + \frac{3}{4} - i} - \frac{1}{z - \frac{3}{4} + \frac{3}{4} + i} \right\} \\
&= \frac{1}{2i} \left[\frac{1}{\frac{3}{4} - i} \left(1 + \frac{z - 3/4}{3/4 - i} \right)^{-1} - \frac{1}{\frac{3}{4} + i} \left(1 + \frac{z - 3/4}{3/4 + i} \right)^{-1} \right] \\
&= \frac{1}{2i} [(3/4 - i)^{-1} \{1 - (z - 3/4) / (3/4 - i) + (z - 3/4)^2 / (3/4 - i)^2 - \dots\} \\
&\quad - (3/4 + i)^{-1} \{1 - (z - 3/4) / (3/4 + i) + (z - 3/4)^2 / (3/4 + i)^2 - \dots\}], \left| z - \frac{3}{4} \right| < \frac{5}{4} \\
&= \frac{16}{25} - \frac{3}{2} \left(\frac{16}{25} \right)^2 \left(z - \frac{3}{4} \right) + \frac{11}{16} \left(\frac{16}{25} \right)^3 \left(z - \frac{3}{4} \right)^2 + \frac{21}{16} \left(\frac{16}{25} \right)^4 \left(z - \frac{3}{4} \right)^4 \quad \dots (2)
\end{aligned}$$

We denote this expansion by $h(z)$, which converges in the right-hand circle $\left| z - \frac{3}{4} \right| < \frac{5}{4}$ and coincides with $g(z)$ in the shaded region. We see that $h(z)$ is clearly a direct analytic continuation of $g(z)$.

Let us construct another analytic continuation of $g(z)$. Now we consider a neighbourhood of the point $z = 1$ (though it is a boundary point of the unit circle the function $f(z)$ is analytic there) and obtain an expansion represented by

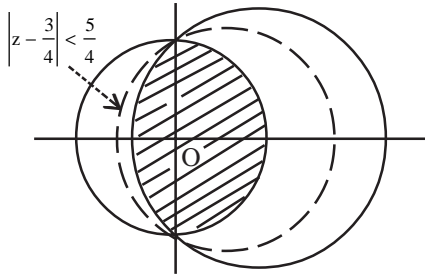

Fig. 3

$$\phi(z) = \frac{1}{2} - \frac{1}{2}(z - 1) + \frac{1}{4}(z - 1)^2 - \dots$$

$$\text{for } |z - 1| < \sqrt{2} \dots (3)$$

In this way we can determine all possible direct analytic continuations of $g(z)$ and then continuations of these continuations and so on. A **complete analytic function** is defined as consisting of the original function and the collection of all the continuations so achieved.

Here the complete analytic function is $\frac{1}{1 + z^2}$, defined in the whole complex plane barring the points $z = \pm i$.

Example 1.3 Consider the function

$$f(z) = \frac{1}{1+z}$$

Clearly this function is analytic everywhere except at $z = -1$. We take a function

$$\phi(z) = 1 - z + z^2 \quad \dots (4)$$

Then sum function $\phi(z)$ is $\frac{1}{1+z}$ in $|z| < 1$. Take a point $z = -1/4$ inside the region

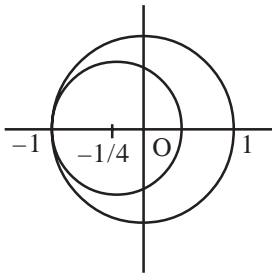

Fig. 4

of convergence of $\phi(z)$ and in a neighbourhood of this point we determine

$$\Psi(z) = \frac{4}{3} \left\{ 1 - \frac{4}{3} \left(z + \frac{1}{4} \right) + \left(\frac{4}{3} \right)^2 \left(z + \frac{1}{4} \right)^2 - \dots \right\}$$

$$\left| z + \frac{1}{4} \right| < \frac{3}{4} \quad \dots (5)$$

It can be checked easily that $\phi(z)$ and $\Psi(z)$ are direct analytic continuation of each other.

Again in the neighbourhood of $z = i/2$ we obtain an expansion

$$k(z) = \frac{1}{1+i/2} \left[1 - \left(\frac{z-i/2}{1+i/2} \right) + \left(\frac{z-i/2}{1+i/2} \right)^2 - \dots \right]$$

$$\left| z - \frac{i}{2} \right| < \frac{\sqrt{5}}{2} \quad \dots (6)$$

In performing analytic continuations we notice that there are certain points which always lie on the boundary of domains in which expansions are not valid. These points are nothing but the singularities of the complete analytic function. In example 1.2 these are $z = \pm i$ whereas it is $z = -1$ for example 1.3.

Regular and Singular points

Let $f(z)$ be an analytic function defined in the domain D , bounded by a simple closed curve Γ . A point $\zeta \in \Gamma$ is called a **regular point** of the function $f(z)$ if there exist a neighbourhood $|z - \zeta| < \epsilon$ of the point ζ and an analytic function $\phi_\zeta(z)$ such that $\phi_\zeta(z) = f(z) \forall z \in D \cap |z - \zeta| < \epsilon$.

The boundary point ζ which is not a regular

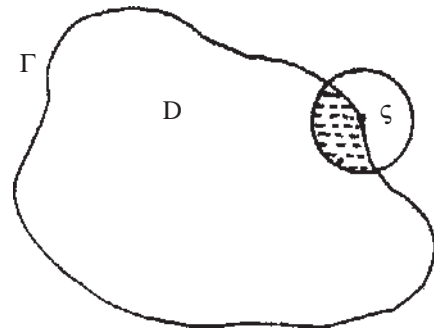

Fig. 6

point is called a **singular point** of $f(z)$ i.e., in any neighbourhood of the point ζ , there cannot be any analytic function coinciding with $f(z)$ in the part common to the neighbourhood of ζ and the domain D .

Natural boundary

In examples 1.2 and 1.3 we have encountered with finite number of singular points situated on the boundary of the region of analyticity of the given function. It might happen that the boundary is dense with singular points. In this case analytic continuation across the boundary of the region is not possible. Such a boundary is called a **natural boundary**.

Example 1.4 Test whether analytic continuation of the function $f(z) = \sum_{n=0}^{\infty} z^{2^n}$ is possible outside its circle of convergence.

Solution : Applying the ratio test we find that the given series

$$f(z) = z + z^2 + z^4 + z^8 + \dots \quad (7)$$

converges for $|z| < 1$. The point $z = 1$ is a singular point of $f(z)$ as it is seen for real z that the sum $\sum_{n=0}^{\infty} x^{2^n}$ increases indefinitely as $x \rightarrow 1$. Now to test whether the circle of convergence, the unit circle, is a natural boundary we examine the behaviour of the given function at the points.

$$z_{k,s} = e^{\frac{i2\pi}{2^k}s}, \quad s = 1, 2, 3, \dots, 2^k$$

(k is any natural number). For this sake we consider the points $\tilde{z}_{k,s} = re^{\frac{i2\pi}{2^k}s}$ $0 < r < 1$ and evaluate $f(z)$ at these points.

$$\text{Then } f(\tilde{z}_{k,s}) = \sum_{n=0}^{k-1} r^{2^n} e^{\frac{i2\pi}{2^k}s \cdot 2^n} + \sum_{n=k}^{\infty} r^{2^n} e^{\frac{i2\pi}{2^k}s \cdot 2^n}$$

and observe that the first term consists of a finite number of terms and hence bounded in absolute value, whereas the second term is absolute value reduces to $\sum_{n=k}^{\infty} r^{2^n}$. Clearly this sum increases indefinitely as $r \rightarrow 1$. This shows that the points $z_{k,s}$ (as $\lim_{r \rightarrow 1} \tilde{z}_{k,s} = z_{k,s}$ are singular points of the

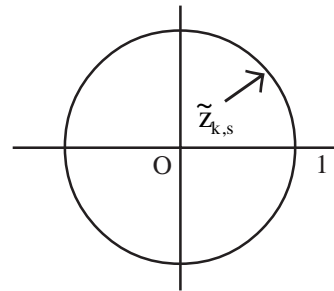

Fig. 7

given function $f(z)$. Now as $k \rightarrow \infty$ these points form an everywhere dense set of points on the boundary of the unit circle. Thus analytic continuation outside the circle of convergence of the given function is not possible.

Example 1.5 Show that the function $f(z) = \sum_{n=1}^{\infty} z^{n!}$ has unit circle as its natural boundary.

Theorem 1.2 Every power series has at least one singular point on its circle of convergence.

Proof. Let $f(z) = a_0 + a_1(z - z_0) + a_2(z - z_0)^2 + \dots$ be any power series with region of convergence $K: |z - z_0| < R$. We shall have to prove there lies at least one singular point on the circle of convergence $\Gamma: |z - z_0| = R$ of the function. Suppose, on the contrary, that every point on Γ are regular points. Let $\zeta_1, \zeta_2, \dots, \zeta_r, \dots$ be certain number of regular points belonging to Γ and $N(\zeta_1), N(\zeta_2), \dots, N(\zeta_r), \dots$ be their neighbourhoods respectively. The points ζ_i 's are chosen in such a way that $N(\zeta_i)$ has non null intersection with $N(\zeta_{i-1})$ and $N(\zeta_{i+1})$ and the union of these neighbourhoods completely cover the boundary Γ . Let D be the union of K and all these neighbourhoods $N(\zeta_i)$. D is open since K and every $N(\zeta_i)$ are open. D is also connected since.

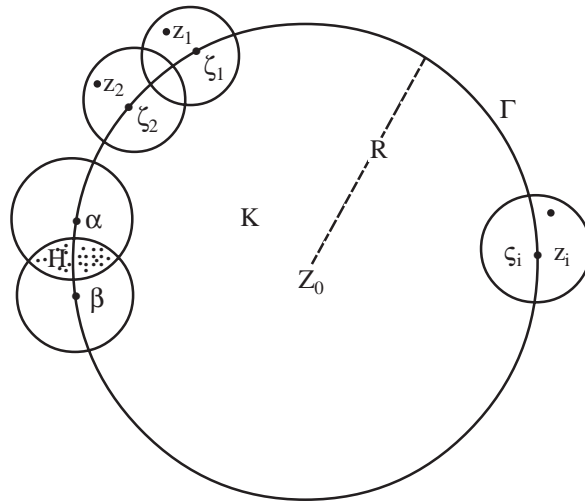

Fig.8

(i) any two points lying in $K \subset D$ can be connected by a straight line segment lying in K , since K is connected.

(ii) one point $z_1 \in N(\zeta_1)$ and the other $z_2 \in K$ can be connected by two straight line segments $\overline{z_1 \zeta_1}$ and $\overline{\zeta_1 z_2}$ lying within $N(\zeta_1) \cup K \subset D$.

(iii) one point $z_m \in N(\zeta_m)$ and $z_n \in N(\zeta_n)$ can be connected by a curve consisting of $\overline{z_m \zeta_m} + \overline{\zeta_m \zeta_n} + \overline{\zeta_n z_n} \subset D$ since $\overline{z_m \zeta_m} \subset N(\zeta_m) \subset D$, $\overline{\zeta_m \zeta_n} \subset \Gamma \subset D$ and $\overline{\zeta_n z_n} \subset N(\zeta_n) \subset D$.

and finally if two points lie in the same neighbourhood $N(\zeta_i)$ it is always connected by a curve $\gamma \subset N(\zeta_i) \subset D$. Now we introduce an analytic function $\psi(z)$ on the open connected set D which satisfies

$$\begin{aligned}\psi(z) &= \phi_{\zeta_i}(z), z \in N(\zeta_i) \\ &= f(z), z \in K\end{aligned}$$

where $\phi_{\zeta_i}(z)$ is a direct analytic continuation of $f(z)$ in the neighbourhood $N(\zeta_i)$ of the regular point ζ_i .

We now prove that $\psi(z)$ is well-defined on D . Let α, β be any two points on Γ such that $H = N(\alpha) \cap N(\beta) \neq \emptyset$ and since α, β are regular points there exist functions $\phi_\alpha(z)$ and $\phi_\beta(z)$ as direct analytic continuations of $f(z)$ in $N(\alpha)$ and $N(\beta)$ respectively i.e.

$$\begin{aligned}\phi_\alpha(z) &= f(z) \quad \forall z \in N(\alpha) \cap K \\ \phi_\beta(z) &= f(z) \quad \forall z \in N(\beta) \cap K\end{aligned}$$

so that $\phi_\alpha(z) = \phi_\beta(z) = f(z) \quad \forall z \in G = (N(\alpha) \cap K) \cap (N(\beta) \cap K) \subset H$. Now since $\phi_\alpha(z), \phi_\beta(z)$ are analytic in H and G is a part of H , by the uniqueness theorem $\phi_\alpha(z) \equiv \phi_\beta(z) \quad \forall z \in H$. As α and β are arbitrary points of Γ we conclude that $\psi(z)$ is a well-defined analytic function on D . Let C be the boundary of D and let $\rho = \overline{z_0\zeta}, \zeta \in C$ be the minimum distance from z_0 to the boundary C of D . Then clearly $\rho > R$ as ζ lies outside the circle Γ . Thus we observe that $\psi(z)$ coincides with $f(z)$ on the disc $|z-z_0| < R$. Then it is obvious to conclude that the radius of convergence of the given power series $\sum_{n=0}^{\infty} a_n(z-z_0)^n$ is ρ , not R , which is a contradiction. Hence every point on Γ cannot be regular points, i.e., there must be at least one singular point on Γ .

1.5 Analytic continuation along a curve

Earlier, analytic continuation by power series method, we have extended $f(z)$ to a

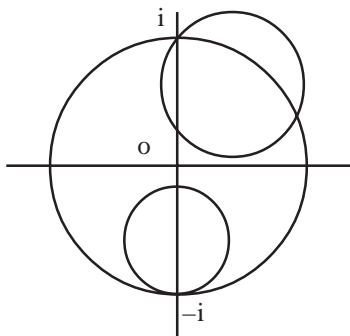

Fig. 9

larger domain considering its power series expansion about a point a from its original circle of convergence with centre at z_0 ($-a \neq z_0$) and radius r . We know, this power series converges in the disc $D_1 : |z - a| < R$, where $R \geq r - |z_0 - a|$ [(see Fig. 9), for example 1.2]. Then it converges to an analytic function $g(z)$ defined on D_1 , which is equal to $f(z)$ on $D \cap D_1$.

Analytic continuation along a curve is an extension of this idea to the situation where a curve is covered by an overlapping sequence of discs and an analytic function defined on the first disc, can be extended successively to each disc in the sequence (see figure 10). We will make this idea more precise after introducing the definition of function element.

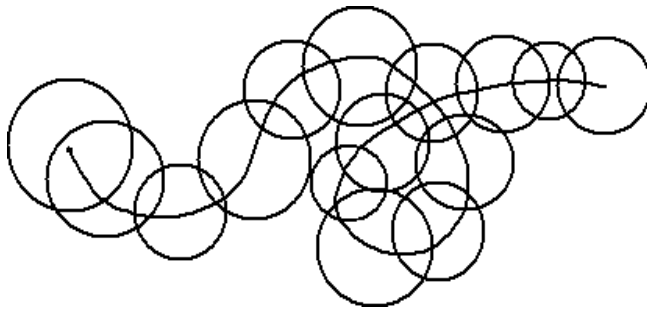

Fig. 10

Definition 1. An ordered

pair (f, D) , where D is a region and f is an analytic function on D is called a **function element**. We say that it is a function element at z_0 if z_0 belongs to D . Two function elements (ϕ, G) and (ψ, H) are equal if and only if $\phi(z) \equiv \psi(z)$, $G = H$.

Clearly a function element (f_1, D_1) is a direct analytic continuation of another function element (f_2, D_2) when $D_1 \cap D_2 \neq \emptyset$ and $f_1 = f_2$ in $D_1 \cap D_2$. In this case the two function elements (f_1, D_1) and (f_2, D_2) are said to be equivalent.

Definition 2. Let $\gamma: [0,1] \rightarrow \mathbb{C}$ be a curve and (f_0, D_0) be a function element at $z_0 = \gamma(0)$. Suppose there exists

(i) a partition $0 = t_0 < t_1 < \dots < t_n = 1$ of $[0, 1]$ and

(ii) a finite sequence of function elements

$$(f_0, D_0), (f_1, D_1), \dots, (f_n, D_n)$$

with $\gamma([t_j, t_{j+1}]) \subset D_j$ and (iii) $f_j(z) = f_{j+1}(z)$ on $D_j \cap D_{j+1}$ for $j = 0, 1, \dots, n-1$.

Then (f_n, D_n) is called an analytic continuation of (f_0, D_0) along γ . Apparently, it seems that the function element (f_n, D_n) of the above definition, depends on the choice of partition $0 = t_0 < t_1 < \dots < t_n = 1$ of $[0, 1]$ and the finite sequence $(f_0, D_0), (f_1, D_1), \dots, (f_n, D_n)$ of function elements. It turns out that up to equivalence, it is actually independent of these choices.

Theorem 1.3 Given a curve $\gamma: [0,1] \rightarrow \mathcal{C}$ beginning at z_0 and ending at z_n and a function element (f_0, D_0) at z_0 , any two analytic continuations of (f_0, D_0) along γ give rise to two function elements at z_n that are direct analytic continuations of each other. [Though the theorem can be proved by taking different partitions of $[0, 1]$ for two different analytic continuations of (f_0, D_0) along γ , here we prove the theorem taking the same partition of $[0, 1]$ for two analytic continuations along γ].

Proof. Let $(f_0, F_0), (f_1, F_1), \dots, (f_n, F_n)$ and $(g_0, G_0), (g_1, G_1), \dots, (g_n, G_n)$ be two analytic continuations of (f_0, D_0) along γ , using the same partition,

$$0 = t_0 < t_1 < \dots < t_n = 1$$

where $\gamma(t_j) = z_j$ and $\gamma([t_j, t_{j+1}]) \subset F_j$ and $\gamma([t_j, t_{j+1}]) \subset G_j$ for $j = 0, 1, \dots, n$.

By given hypothesis, $(f_0, D_0) = (f_0, F_0) = (g_0, G_0)$. Now we set $E_j = F_j \cap G_j$ for $j = 1, 2, \dots, n$, and $E_0 = F_0 = G_0$. Then each E_j is a connected open set containing $\gamma(t_j)$ and $\gamma(t_{j+1})$. To prove the theorem we show, by induction, that $f_n = g_n$ on E_n .

We have $f_0 = g_0$ on $E_0 = F_0 = G_0$ by definition. Suppose $j < n$ and $f_j = g_j$ on E_j . But we have

$$f_j = f_{j+1} \quad \text{on } F_j \cap F_{j+1}$$

and
$$g_j = g_{j+1} \quad \text{on } G_j \cap G_{j+1}$$

and $\gamma(t_{j+1})$ is common to both the open sets $F_j \cap F_{j+1}$ and $G_j \cap G_{j+1}$. So it follows that

$$f_{j+1} = g_{j+1}$$

in a neighbourhood of $\gamma(t_{j+1})$ and hence on E_{j+1} by the uniqueness theorem. By induction the proof is therefore complete.

Homotopic curves. Two arcs γ_1 and γ_2 , with common end points, contained in a region R are said to be homotopic if one can be obtained from the other by continuous deformation where the process of continuous deformation must be confined in R .

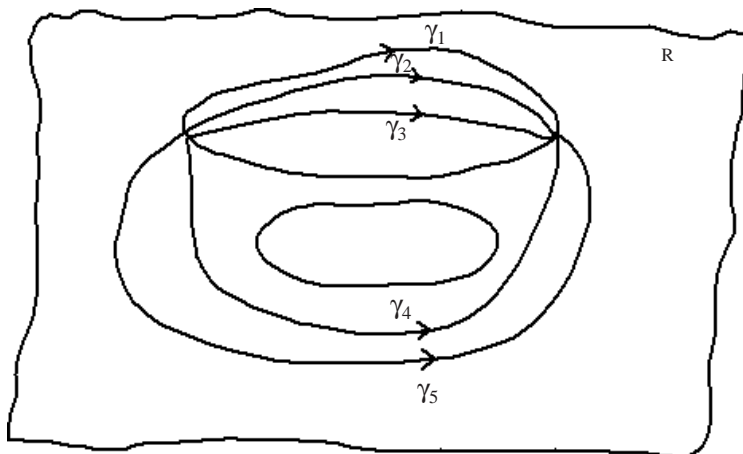

In the given figure $\{\gamma_1, \gamma_2 \text{ and } \gamma_3\}$ is one set of homotopic curves while $\{\gamma_4, \gamma_5\}$ is the other set. Here no curve of the first set is homotopic to any curve of the second set. These are geometrical interpretations. We now explain such a deformation in an analytical manner.

Let us suppose $\gamma_0 : z = \sigma_0(t), 0 \leq t \leq 1$ and $\gamma_1 : z = \sigma_1(t), 0 \leq t \leq 1$ be two curves, lying in a region R , having common end points a and b i.e., $a = \sigma_0(0) = \sigma_1(0)$ and $b = \sigma_0(1) = \sigma_1(1)$ hold. We say that the curve γ_0 can be continuously deformed into the curve γ_1 keeping the process confined to R , if there exists a function $\sigma(t, s)$ which is continuous in the unit square $I^2 = I \times I, I = [0, 1]$ and satisfies the following conditions :

- (i) for each fixed $s \in [0, 1]$ the curve $\gamma_s : z = \sigma(t, s), 0 \leq t \leq 1$ lies in R .
- (ii) $\sigma(t, 0) = \sigma_0(t)$ and $\sigma(t, 1) \equiv \sigma_1(t), 0 \leq t \leq 1$
- (iii) $\sigma(0, s) \equiv a$ and $\sigma(1, s) \equiv b, 0 \leq s \leq 1$.

Let α and ζ be two points lying in a domain D and suppose that γ_0 and γ_1 are two curves connecting α to ζ . Let there exist, as in definition 2, two finite sequences of function elements $(f_0, G_0), (f_1, G_1) \dots, (f_n, G_n)$ and $(g_0, H_0), (g_1, H_1), \dots, (g_m, H_m)$ along the curves γ_0 and γ_1 respectively. We also suppose that the function elements (f_0, G_0) and (g_0, H_0) at the point α are equivalent. Then a question arises whether the function elements (f_n, G_n) and (g_m, H_m) at the point ζ are also equivalent? If γ_0 and γ_1 are the same curve the Th. 1.3 confirms the answer for equivalence. However, if γ_0 and γ_1 are distinct there is no definite answer. The reason behind this is the fact that the regions enclosed by the curves γ_0 and γ_1 may contain points at which we can not find any function element that can be included in the sequence of function elements from the point α to ζ along any curve passing through these points. Here we discuss a few problems highlighting these facts :

Example 1.6 Let $Q_1 = \{z \in \mathbb{C} \mid \operatorname{Re} z > 0, \operatorname{Im} z > 0\}$ denote the first quadrant and set $f(z) = \log z$ for all $z \in Q_1$

Show that, if g_1 is the analytic continuation to $\mathbb{C} \setminus (-\infty, 0]$ of f and g_2 is the analytic continuation to $\mathbb{C} \setminus [0, \infty)$ of f , then $g_1 \neq g_2$ throughout the third quadrant, $Q_3 = \{z \in \mathbb{C} \mid \operatorname{Re} z < 0, \operatorname{Im} z < 0\}$.

Proof. Clearly, g_1 is the principal branch of $\log z$ throughout $\mathbb{C} \setminus (-\infty, 0]$

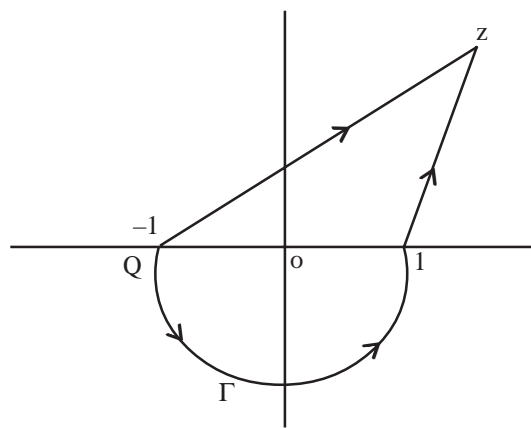

Fig. 10

by the uniqueness theorem. That is

$$g_1(z) = \int_{[1,z]} \frac{d\zeta}{\zeta}$$

for all z barring the negative real axis including origin. We define

$$(i) \quad g_2(z) = \int_{[-1,z]} \frac{d\zeta}{\zeta} + i\pi \text{ for all } z \in \mathbb{C} \setminus [0, \infty]$$

and show that

$$(ii) \quad g_2(z) = g_1(z) + 2\pi i \text{ for all } z \in Q_3.$$

Let γ be the closed curve (see figure) consisting of the line segments $[1, z]$, $[z, -1]$ and a semi-circular path Γ with centre at the origin and radius 1, where z is any point in Q_1 .

Now we wish to calculate

$$\int_{\gamma} \frac{d\zeta}{\zeta}$$

By Cauchy's Residue Theorem, it is equal to $2\pi i$ origin is the only pole inside γ). So breaking up the contour γ , we can equate

$$\begin{aligned} 2\pi i &= \int_{[1,z]} \frac{d\zeta}{\zeta} + \int_{[z,-1]} \frac{d\zeta}{\zeta} + \int_{\Gamma} \frac{d\zeta}{\zeta} \\ &= g_1(z) - \int_{[-1,z]} \frac{d\zeta}{\zeta} + i\pi \end{aligned}$$

$$\text{i.e.,} \quad g_1(z) - \int_{[-1,z]} \frac{d\zeta}{\zeta} + i\pi = g_2(z)$$

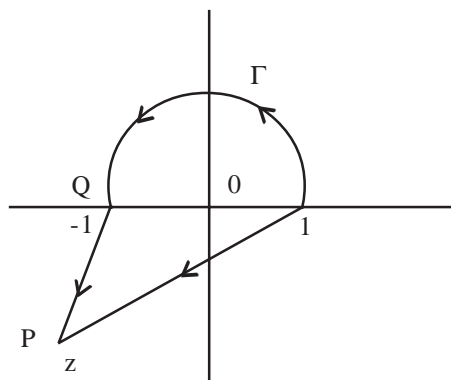

Fig. 11

Hence $g_2(z) = g_1(z) = \log z$ for all $z \in Q_1$, that is, the mapping g_2 defined in (i) is the unique analytic continuation of f to $\mathbb{C} \setminus [0, \infty)$.

To prove (ii) Let $z \in Q_3$ and γ be the curve joining the line segments $[-1, z]$, $[z, +1]$ and a unit semi-circular path Γ in the upper half plane. Thus

$$\begin{aligned} 2\pi i &= \int_{\gamma} \frac{d\zeta}{\zeta} = \int_{\Gamma} \frac{d\zeta}{\zeta} + \int_{[-1,z]} \frac{d\zeta}{\zeta} + \int_{[z,-1]} \frac{d\zeta}{\zeta} \\ &= \pi i + \int_{[-1,z]} \frac{d\zeta}{\zeta} - g_1(z) \end{aligned}$$

i.e., $g_2(z) = g_1(z) + 2\pi i$ for all $z \in Q_3$.

Remark : The preceding example presents the following observation : If γ_1 and γ_2 be the two curves joining z_0 and ζ , (f_0, D_0) be a function element at z_0 , then the resulting function elements of (f_0, D_0) along the curves γ_1 and γ_2 at ζ may not be direct analytic continuations of each other. We shall now discuss for what reasons such type of situation occurs.

1.6 Multi-valued Functions and Analytic continuation

When we define both real and complex functions we always keep in mind that for each value of the independent variables the value of the function must be unique. For example, even Cauchy's theorem is based on the assumption that a function can be defined uniquely in the region under consideration. All the same, multivaluedness often arises out of necessity in the actual construction of functions, the simplest example is perhaps the logarithm :

In section 5.2 [14] we showed that if z is a non zero complex number, then the equation $z = e^\omega$ has infinitely many solutions. Since the function $f(\omega) = e^\omega$ is a many-to-one mapping, its inverse (the logarithm) is multi-valued.

Definition 3 : [Multi-valued logarithm] : For $z \neq 0$, we define the function $\log z$ as the inverse of the exponential function; that is,

$$\log z = \omega \text{ if and only if } z = e^\omega \quad (8)$$

If we go through the same steps as we did to obtain (5.5) [14], we find that, for any complex number $z \neq 0$, the solutions ω to equation (8) take the form

$$\omega = \log z = \log |z| + i\theta, \text{ for } z \neq 0 \quad (9)$$

where $\theta \in \arg z$ and $\log |z|$ denotes the natural logarithm of the positive number $|z|$. Because $\arg z$ is the set $\arg z = \text{Arg } z + 2n\pi$, where n is an integer, we can express the set of values comprising $\log z$ as

$$\log z = \log |z| + i (\text{Arg } z + 2n\pi), \text{ where } n = \text{integer} \quad (10)$$

$$\text{or} \quad \log z = \log |z| + i \arg z \text{ for } z \neq 0, \quad (11)$$

where it is understood that the identity (11) refers to the same set of numbers given in identity (10).

We call any one of the values given in identities (10) or (11) a logarithm of z . Notice that the different values of $\log z$ all have the same real part and that their imaginary parts differ by the amount $2n\pi$, where n is an integer. Regarding analytic continuation, we treat $\log z$ for complex valued z as the extension of $\log x$ from positive real domain to complex domain. Consider the Taylor series expansion of $\log x$:

$$\log x = \log\{1 + (x - 1)\} = \sum_{n=1}^{\infty} \frac{(-1)^{n-1}}{n} (x - 1)^n, 0 < x < 2 \quad (12)$$

We take this series for complex valued z and write

$$f_0(z) = \sum_{n=1}^{\infty} \frac{(-1)^{n-1}}{n} (z - 1)^n \quad (13)$$

which converges in the disc $K_0 : |z-1| < 1$ so that $f_0(x) = \log x$ for $0 < x < 2$. Thus $f_0(z)$ and $\log x$ are direct analytic continuations of each other.

Our object is to specify the curves along which the analytic continuation of the function element (f_0, K_0) is possible. For this purpose it is advantageous to apply the integral representation.

$$\log x = \int_1^x \frac{ds}{s}, 0 < x < \infty \quad (14)$$

Lemma 1.1. The following formula

$$f_0(z) = \int_1^z \frac{d\zeta}{\zeta} \quad (15)$$

holds for $z \in K_0$ where the integral is taken along any path lying completely within K_0 .

Proof. The function $f_0(z)$ given by (13) is regular in K_0 and following Theorem 3.2[14] the integral on the r.h.s of (15) is also regular in K_0 . But we see that this integral coincides with $\log x$ in (14) for $0 < x < 2$. By the uniqueness theorem.

$$f_0(z) = \sum_{n=1}^{\infty} \frac{(-1)^{n-1}}{n} (z - 1)^n = \int_1^z \frac{d\zeta}{\zeta}, z \in K_0.$$

In continuing $f_0(z)$ analytically to an arbitrary point ω we isolate a single-valued piece of $\log z$, as we shall do later for other multivalued functions, called a branch of the function. The standard way to isolate **single-valued branches** is by the use of branch cuts to different branches. For $\log z$ the question of multivaluedness arises when z goes around the origin, as a result argument changes by 2π . Such a point is called a **branch point**. If we do not allow the paths to travel around a branch point of a multi-valued function then certainly we would not face varied values at a point lying in the domain of definition of the function.

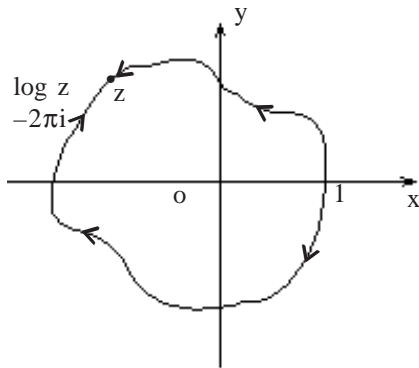

Fig. 12

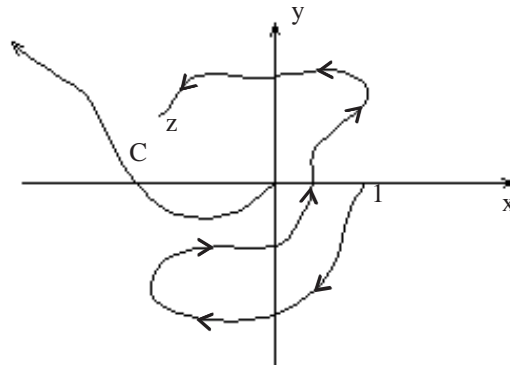

Fig. 13

Let C be any simple curve from 0 to ∞ , so that z cannot go around the origin crossing C .

The above consideration shows that if analytic continuation along a given curve Γ is possible, then one can get from a function element at the initial point of the curve another function element at the terminal point of the curve by a finite number of applications of direct analytic continuation. If there is no function element at the initial point of Γ that can be continued along Γ , then there exists a definite point on the curve Γ which is a singular point at which the process of analytic continuation must stop.

The following question immediately arises : if ω is some non-singular point outside the disc D_0 , then there may two or more chains of function elements which eventually continue analytically $f_0(z)$ onto a disc D containing ω . For example, let (f_j, D_j) be the function element of one chain and (f_k, D_k) be the function element of a different chain and that $\omega \in D_j \cap D_k$; will then $f_j(z) = f_k(z) \forall z \in D$?

The Monodromy Theorem

The above question is answered by the Monodromy theorem, which, simply stated, is : if there are no singular points in between the two paths of analytic continuation, then the result of analytic continuation is the same for each path. Another way of stating the theorem is :

Theorem 1.4 [Monodromy Theorem] Let (f_0, D_0) be a function element at z_0 and R be a simply connected region containing D_0 , ζ be any point lying in R . We suppose

- (i) (f_0, D_0) can be analytically continued along every curve in R .
- (ii) γ_0 and γ_1 are homotopic curves from z_0 to ζ .

Then the continuations of the function element (f_0, D_0) along γ_0 and γ_1 at ζ are equivalent.

Proof. A homotopy from γ_0 to γ_1 determines a continuous one parameter family of curves $\{\gamma_s\}$, $0 \leq s \leq 1$ from z_0 to ζ given by the equations $z = \sigma_s(t)$, $0 \leq t \leq 1$.

By hypothesis, the function element (f_0, D_0) has an analytic continuation along each of the curves, γ_s . Denote the terminal function element at ζ for the continuation along γ_s by ϕ_s . We claim that, for each $k \in [0, 1]$, there is a $\delta > 0$ such that ϕ_s is equivalent to ϕ_k whenever $|s-k| < \delta$.

Let $0 = t_0 < t_1 < \dots < t_n = 1$ be a partition and $(f_0, D_0), (f_1, D_1), \dots, (f_n, D_n)$ be a finite sequence of function elements defining $\phi_k = (f_n, D_n)$ as the terminal function element at ζ for the analytic continuation of (f_0, D_0) along γ_k . Then

$$E_j = \sigma_k([t_j, t_{j+1}]) \subset D_j \text{ for } j = 0, 1, \dots, n-1$$

For each $j = 0, 1, \dots, n-1$, let ϵ_j be the minimum distance from the compact set E_j to the boundary of the D_j . If $|\sigma_s(t) - \sigma_k(t)| < \epsilon_j$, $t \in [0, 1]$, then it will also be true that $\sigma_s([t_j, t_{j+1}]) \subset D_j$. Thus, if $\epsilon = \min \{\epsilon_0, \epsilon_1, \dots, \epsilon_{n-1}\}$ and we choose $\delta > 0$ such that $|\sigma_s(t) - \sigma_k(t)| < \epsilon$ whenever $|s-k| < \delta$, then for each s with $|s-k| < \delta$, the partition $0 = t_0 < t_1 < \dots < t_n = 1$ and sequence of function elements $(f_0, D_0), (f_1, D_1), \dots, (f_n, D_n)$ also defines (f_n, D_n) as the terminal function element at ζ for the analytic continuation of (f_0, D_0) along γ_s . Since, by the previous theorem 1.3, any other continuation of (f_0, D_0) along γ_s results function element equivalent to this one, we conclude that ϕ_k is equivalent to ϕ_s . This proves that ϕ_s is equivalent to ϕ_k whenever $|s-k| < \delta$.

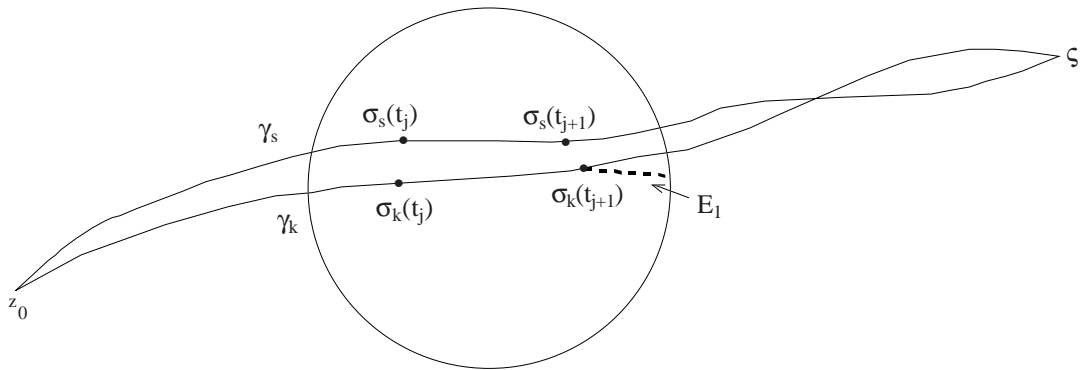

Fig. 14

This means that for every $s \in I = [0, 1]$ there is a positive $\delta(s)$ such that if s lies in the interval $I_s = (s - \delta(s), s + \delta(s))$, then the analytic continuation of $f_0(z)$ along all such curves γ_s , result equivalent function elements at the point ζ . Now by the Heine-Borel theorem, we can always choose a finite number of intervals I_{s_j} , $0 = s_0 < s_1 < \dots < s_n = 1$ that cover the segment I and are such that the intervals I_{s_j} and

$I_{s_{j+1}}$, $0 \leq j \leq n-1$ have a non-empty intersection. Then, if $s \in I_{s_0} \cap I_{s_1}$, the analytic continuation of $f_0(z)$ result equivalent function elements at the point ζ . The same is true for $s \in I_{s_1} \cap I_{s_2}$ and so on. Continuing in this way we observe that the analytic continuation of the function element (f_0, D_0) along all the curves γ_s , $0 \leq s \leq 1$ produce equivalent function elements at the point ζ . This completes the proof of the theorem.

The above theorem leads us to the following most important corollary.

Corollary. Let R be a simply connected region and

- (i) (f_0, D_0) be a function element at z_0 belonging to R
- (ii) (f_0, D_0) admit analytic continuation along every curve in R .

Then there is a function F which is analytic on R and coincides with f_0 on D_0 .

Proof. Let z_1 be a point in R . Then, since R is simply connected any two curves from z_0 , to z_1 are homotopic in R . The Monodromy theorem implies that any two terminal function elements of analytic continuations of (f_0, D_0) along curves from z_0 to z_1 in R will be equivalent and hence, will determine a function F_1 analytic in some neighbourhood of z_1 , say Q_1 .

Clearly, $F_1(z) = f_0(z)$ on D_0 , $F_1(z) = f_1(z)$ on D_1 , ..., etc for the continuation along the curve γ_1 from z_0 to z_1 .

Again let z_2 be a point in R , and γ_2 be a curve in R joining z_0 to z_2 and let (g_n, E_n) be the function element at z_2 continuing along the curve γ_2 with $f_0 = g_0$ on $D_0 = E_0$. We simply join z_2 to z_1 by a curve γ and claim that continuation of (F_1, Q_1) , along the curve γ to z_2 , will be equivalent to (g_n, E_n) (since the curves $\gamma_1 \cup \gamma$ and γ_2 are homotopic), which gives rise to the fact that there is a function F_2 analytic in some neighbourhood of z_2 , say Q_2 , which coincides with F_1 On Q_1 .

Clearly, $F_2(z)$ possesses larger domain of analyticity than $F_1(z)$. Proceeding in this way finite number of times we can achieve a function F analytic throughout the region R .

Unit 2 □ Harmonic Functions

Structure

2.0 Objectives

2.1 Harmonic Function

2.2 Gauss' Mean Value Theorem for harmonic

2.3 Inverse point of a given point with respect to a circle

2.4 The Dirichlet Problem

2.5 Subharmonic & Superharmonic Functions

2.0 Objectives

In this chapter we shall mainly study harmonic functions and their basic properties. Gauss' mean value theorem, Poisson's integral formula, Dirichlet's problem for a disc and Harnack inequality for harmonic functions will be discussed. Subharmonic and superharmonic functions will be explained through examples.

2.1 Harmonic Function

A function $u(x, y)$ of two real variables x and y defined in an open set D is said to be harmonic in D if it has continuous derivatives of the second order and satisfies the equation

$$\frac{\partial^2 u}{\partial x^2} + \frac{\partial^2 u}{\partial y^2} = 0 \quad (16)$$

known as Laplace's equation.

The differential operator $\frac{\partial^2}{\partial x^2} + \frac{\partial^2}{\partial y^2}$ is called the Laplacian and is denoted by ∇^2 .

We introduce the differential operators

$$\frac{\partial}{\partial z} = \frac{1}{2} \left(\frac{\partial}{\partial x} - i \frac{\partial}{\partial y} \right) \text{ and } \frac{\partial}{\partial \bar{z}} = \frac{1}{2} \left(\frac{\partial}{\partial x} + i \frac{\partial}{\partial y} \right) \quad (17)$$

in order to achieve a condition equivalent to (16) for $f(z)$. If we write

$$x = \frac{1}{2}(z + \bar{z}) \text{ and } y = \frac{1}{2i}(z - \bar{z}) \quad (18)$$

then

$$\left. \begin{aligned} \frac{\partial f}{\partial z} &= \frac{\partial f}{\partial x} \cdot \frac{\partial x}{\partial z} + \frac{\partial f}{\partial y} \cdot \frac{\partial y}{\partial z} = \frac{1}{2} \frac{\partial f}{\partial x} + \frac{1}{2i} \frac{\partial f}{\partial y} \\ \frac{\partial f}{\partial \bar{z}} &= \frac{\partial f}{\partial x} \cdot \frac{\partial x}{\partial \bar{z}} + \frac{\partial f}{\partial y} \cdot \frac{\partial y}{\partial \bar{z}} = \frac{1}{2} \frac{\partial f}{\partial x} - \frac{1}{2i} \frac{\partial f}{\partial y} \end{aligned} \right\} (19a-b)$$

$$\begin{aligned} \frac{\partial^2 f}{\partial z \partial \bar{z}} &= \frac{1}{2} \left[\frac{\partial^2 f}{\partial x^2} \cdot \frac{\partial x}{\partial z} + \frac{\partial^2}{\partial x \partial y} \cdot \frac{\partial y}{\partial z} \right] - \frac{1}{2i} \left[\frac{\partial^2 f}{\partial x \partial y} \cdot \frac{\partial x}{\partial \bar{z}} + \frac{\partial^2 f}{\partial y^2} \cdot \frac{\partial y}{\partial \bar{z}} \right] \\ &= \frac{1}{4} f_{xx} + \frac{1}{4i} f_{xy} - \frac{1}{4i} f_{xy} + \frac{1}{4} f_{yy} = \frac{1}{4} (f_{xx} + f_{yy}) \end{aligned}$$

and consequently the condition equivalent to (16) is

$$\nabla^2 f = 4 \frac{\partial^2 f}{\partial z \partial \bar{z}} \quad (20)$$

A function $f(z)$ is said to be harmonic in D if f has continuous second derivatives in D and satisfies

$$\nabla^2 f = 0, \forall z \in D \quad (21)$$

Result 1 : If $f = u + iv$ is analytic in a domain D , then $\frac{\partial f}{\partial \bar{z}} = 0, \forall z \in D$.

Proof : u and v satisfy the Cauchy-Riemann equations and using (19b) we have,

$$\begin{aligned} \frac{\partial f}{\partial \bar{z}} &= \frac{1}{2}(u_x + iv_x) - \frac{1}{2i}(u_y + iv_y) \\ &= \frac{1}{2}(u_x + iv_x) - \frac{1}{2i}(-v_x + iu_x), \text{ using C-R equations} \\ &= 0 \end{aligned}$$

Result 2 : The real and imaginary parts of an analytic function are harmonic.

Proof : Let $f = u + iv$ be analytic in a domain D . By Cauchy-Riemann equations

$$u_x = v_y \text{ and } u_y = -v_x$$

i.e. $u_{xx} = v_{xy}$ and $u_{yy} = -v_{xy}$ [since $v_{xy} = v_{yx}$, partial derivatives being continuous] and on addition it proves that u is harmonic in D . Likewise v is also harmonic in D .

Harmonic conjugates : Let $u(x, y)$ and $v(x, y)$ be two harmonic functions in a domain $D \subseteq \mathbb{C}$.

If they satisfy the Cauchy-Riemann equations :

$$\frac{\partial u}{\partial x} = \frac{\partial v}{\partial y}, \quad \frac{\partial u}{\partial y} = -\frac{\partial v}{\partial x}, \quad \text{in } D, \text{ then}$$

we say that v is a harmonic conjugate of u . It follows that $f(z) = u(x, y) + i v(x, y)$ is analytic in a domain D if and only if $v(x, y)$ is a harmonic conjugate of $u(x, y)$ in D .

Remark : We know that the real part as well as the imaginary part of an analytic function are harmonic. Now the questions arise :

1. Can any real harmonic function be the real part of an analytic function?
2. Whether every real harmonic function has a harmonic conjugate?

Existence of Harmonic conjugates

Theorem 2.1 Let $u(x, y)$ be a real-valued harmonic function in a simply connected domain $D \subseteq \mathcal{C}$. Then there is an analytic function f in D such that $u = \operatorname{Re} f$ (or, equivalently there is a function v , a harmonic conjugate of u) which is unique to within addition of an arbitrary real constant.

Proof. Since the function $u(x, y)$ is harmonic in a simply connected domain D , we have

$$\frac{\partial^2 u}{\partial x^2} + \frac{\partial^2 u}{\partial y^2} = 0$$

which can be rewritten as

$$\frac{\partial}{\partial y} \left(-\frac{\partial u}{\partial y} \right) = \frac{\partial}{\partial x} \left(\frac{\partial u}{\partial x} \right), \quad \text{where } -\frac{\partial u}{\partial y} \text{ and } \frac{\partial u}{\partial x} \text{ are given functions with continuous}$$

first partial derivatives. This implies that

$$-\left(\frac{\partial u}{\partial y} \right) dx + \left(\frac{\partial u}{\partial x} \right) dy$$

is exact. So there is a single-valued function $v(x, y)$ which is unique to within an additive arbitrary constant, i.e.

$$v(x, y) = \int_{(x_0, y_0)}^{(x, y)} -\frac{\partial u}{\partial y} dx + \frac{\partial u}{\partial x} dy + K \quad (22)$$

$K \equiv$ real constant,

where (x_0, y_0) is an initial point and (x, y) is any variable point lying in D and the integral on the curve connecting (x_0, y_0) to (x, y) is path independent.

From (22) we find that

$$\frac{\partial v}{\partial x} = -\frac{\partial u}{\partial y}, \quad \frac{\partial v}{\partial y} = \frac{\partial u}{\partial x},$$

which in turn ensures that $v(x, y)$ is harmonic in D and harmonic conjugate to $u(x, y)$ i.e. $f = u + iv$ forms an analytic function in D .

Observation : If D is multiply connected then the integral in (22) may take different values for different paths connecting (x_0, y_0) , to (x, y) giving $v(x, y)$ as a multi-valued function, unless the paths are restricted to a simply connected sub domain contained in D .

Example 1. Let D be the whole plane cut along the negative real axis including the origin ($y = 0, x \leq 0$). Show that $u(x, y) = \sin x \cosh y$ is harmonic in D , and find its harmonic conjugate. Also find the corresponding analytic function.

Solution : Here $u(x, y)$ possesses continuous second order partial derivatives in D and also satisfies the Laplace equation : $u_{xx} + u_{yy} = 0$. Hence $u(x, y)$ is harmonic in D .

Let $v(x, y)$ be its harmonic conjugate. Then according to the formula (22), we have

$$v(x, y) = \int_{(1,0)}^{(x,y)} \left(-\frac{\partial u}{\partial y} dx + \frac{\partial u}{\partial x} dy \right) + K, \quad K \equiv \text{real constant},$$

where $M(1, 0)$ is the initial point.

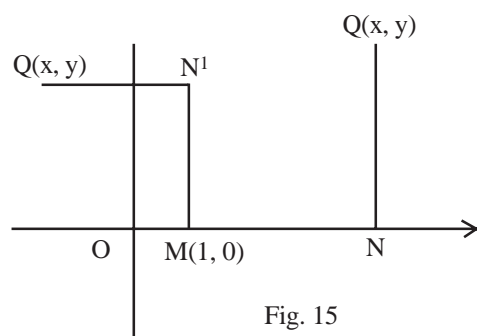

Fig. 15

Here, $u(x, y) = \sin x \cosh y$

$$u_x = \cos x \cosh y$$

$$u_y = \sin x \sinh y$$

Now let the point $Q(x, y)$ lie in the 1st quadrant of the right-half plane. Then integrating along MNQ , we find that

$$v(x, y) = \int_{MN} -\frac{\partial u}{\partial y} dx + \int_{NQ} -\frac{\partial u}{\partial x} dy + K_1$$

$$= -\int_1^x \sin x \sinh 0 dx + \int_0^y \cos x \cosh y dy + K_1$$

$$= \cos x \sinh y + K_1$$

Again, if the point (x, y) lies in the 2nd quadrant of the left-half plane, then we obtain

$$v(x, y) = \int_{MN^1} \frac{\partial u}{\partial x} dy + \int_{N^1Q} -\frac{\partial u}{\partial y} dx + K_2$$

$$= \int_0^y \cos 1 \cosh y dy + \int_1^x -\sin x \sinh y dx + K_2$$

$$= \cos 1 \sinh y + \cos x \sinh y - \cos 1 \sinh y + K_2$$

$$= \cos x \sinh y + K_2$$

The expression for $v(x, y)$ in both the cases turns out to be the same apart from an additive constant. It results from the fact that the two paths in determining the

integral lie in a simply connected domain. Thus, $v(x, y) = \cos x \sinh y + K$ at all points of D . Therefore, an analytic function with the given real part will be of the form

$$\begin{aligned} f(z) &= \sin x \cosh y + i \cos x \sinh y + iK, \quad K \equiv \text{real constant} \\ &= \sin(x + iy) + iK \\ &= \sin z + iK \end{aligned}$$

As for uniqueness, if two analytic functions in D have the same real part, then their difference has derivative zero, by the Cauchy-Riemann equations. In that case the functions differ by a constant.

2.2 Gauss' Mean Value Theorem for harmonic functions

Let $u(z) = u(x, y)$, $z = x + iy$, be harmonic in the disk $K : |z - z_0| < R$ and continuous on the closed disk \bar{K} . Then

$$u(z_0) = \frac{1}{2\pi} \int_0^{2\pi} u(z_0 + Re^{i\theta}) d\theta \quad (23)$$

Proof. Let $f(z)$ be an analytic function defined in K such that $\text{Re } f(z) = u(z)$. It follows from Cauchy's integral formula that

$$f(z_0) = \frac{1}{2\pi i} \int_{|z-z_0|=r} \frac{f(z)}{z - z_0} dz, \quad 0 < r < R$$

using the parametric form of the circle $|z - z_0| = r$.

$z = z_0 + re^{i\theta}$, $0 \leq \theta \leq 2\pi$, so that $dz = ire^{i\theta} d\theta$. The integral then gives

$$f(z_0) = \frac{1}{2\pi} \int_0^{2\pi} f(z_0 + re^{i\theta}) d\theta, \quad 0 < r < R$$

Equating the real parts, we obtain

$$u(z_0) = \frac{1}{2\pi} \int_0^{2\pi} u(z_0 + re^{i\theta}) d\theta$$

whence taking the limit $r \rightarrow R$, we obtain the desired result (23)

2.3 Inverse point of a given point with respect to a circle

Let $\gamma : |z - \alpha| = R$ and z_0 be a given point. Let z_1 be another point on the radius through z_0 such that $|z_0 - \alpha| |z_1 - \alpha| = R^2$. Then either of the points z_0 and z_1 is called the inverse point of the other with respect to γ . The centre of the circle γ is called the centre of inversion.

It follows from the definition that (i) if z_0 lies inside γ , then z_1 must lie outside

γ , (ii) if z_0 lies on γ , then z_1 must also lie on γ and it coincides with z_0 , (iii) if z_0 lies outside γ , then z_1 must lie inside γ .

Every point, except the centre of the circle, on the plane has a unique inverse point with respect to the circle. We associate the point at infinity to the inverse point of the centre.

Result : Let $\gamma : |z| = R$ and z_0 be a given point. Then the inverse point of z_0 with respect to γ is given by $\frac{R^2}{\bar{z}_0}$.

Proof : Let $z_0 = re^{i\theta}$. Then its inverse point with respect to γ is given by $z_1 = r_1e^{i\theta}$, where $rr_1 = R^2$. Hence $r_1 = \frac{R^2}{r}$ and so

$$z_1 = \frac{R^2}{r} \cdot e^{i\theta} = \frac{R^2}{re^{-i\theta}} = \frac{R^2}{\bar{z}_0}$$

Poisson's integral formula : Theorem : Let $u(x, y)$ be a harmonic function in a simply connected region D and $\gamma : |\zeta| = R$ be a circle contained in D . Then for any $z = re^{i\theta}$, $r < R$, u can be written as $u(r, \theta) = \frac{1}{2\pi} \int_0^{2\pi} \frac{(R^2 - r^2) \cdot u(R, \phi) d\phi}{R^2 + r^2 - 2Rr \cos(\phi - \theta)}$, where $Re^{i\phi}$ is a point on γ .

Proof : Since $u(x, y)$ is harmonic in D , there exists a conjugate harmonic function $v(x, y)$ in D so that $f(z) = u(x, y) + iv(x, y)$ is analytic in D . Then $f(z)$ is analytic within and on γ and so for any z within γ , by Cauchy's integral formula,

$$f(z) = \frac{1}{2\pi i} \int_{\gamma} \frac{f(\zeta)}{\zeta - z} d\zeta \quad (24)$$

The inverse point of z with respect to γ lies outside γ and is given by $\frac{R^2}{\bar{z}}$. Hence by Cauchy-Goursat theorem,

$$0 = \frac{1}{2\pi i} \int_{\gamma} \frac{f(\zeta)}{\zeta - \frac{R^2}{\bar{z}}} d\zeta \quad (25)$$

Subtracting (25) from (24) we get,

$$f(z) = \frac{1}{2\pi i} \int_{\gamma} \left\{ \frac{1}{\zeta - z} - \frac{1}{\zeta - \frac{R^2}{\bar{z}}} \right\} f(\zeta) d\zeta$$

$$= \frac{1}{2\pi i} \int_{\gamma} \frac{\left(z - \frac{R^2}{\bar{z}}\right) f(\zeta) d\zeta}{(\zeta - z) \left(\zeta - \frac{R^2}{\bar{z}}\right)} \quad (26)$$

Let $\zeta = Re^{i\phi}$. Also, $\bar{z} = re^{-i\theta}$. Then (26) becomes

$$\begin{aligned} f(re^{i\theta}) &= \frac{1}{2\pi i} \int_0^{2\pi} \frac{\left(re^{i\theta} - \frac{R^2}{r} e^{i\phi}\right) f(Re^{i\phi}) i Re^{i\theta} d\phi}{(Re^{i\theta} - re^{i\theta}) \left(Re^{i\phi} - \frac{R^2}{r} e^{i\theta}\right)} \\ &= \frac{1}{2\pi} \int_0^{2\pi} \frac{(r^2 - R^2) e^{i(\phi+\theta)} f(Re^{i\phi}) d\phi}{(Re^{i\phi} - re^{i\theta})(re^{i\phi} - Re^{i\theta})} \\ &= \frac{1}{2\pi} \int_0^{2\pi} \frac{(R^2 - r^2) f(Re^{i\phi}) d\phi}{(Re^{i\phi} - re^{i\theta})(Re^{-i\phi} - re^{-i\theta})} \\ &= \frac{1}{2\pi} \int_0^{2\pi} \frac{(R^2 - r^2) f(Re^{i\phi}) d\phi}{R^2 + r^2 - 2Rr \cos(\phi - \theta)} \end{aligned} \quad (27)$$

Let $f(re^{i\theta}) = u(r, \theta) + iv(r, \theta)$. Then (27) becomes

$$u(r, \theta) + iv(r, \theta) = \frac{1}{2\pi} \int_0^{2\pi} \frac{(R^2 - r^2) \{u(R, \phi) + iv(R, \phi)\}}{R^2 + r^2 - 2Rr \cos(\phi - \theta)} d\phi \quad (28)$$

Equating real parts in (28) we get,

$$u(r, \theta) = \frac{1}{2\pi} \int_0^{2\pi} \frac{(R^2 - r^2) u(R, \phi)}{R^2 + r^2 - 2Rr \cos(\phi - \theta)} d\phi \quad (29)$$

Formula (29) is known as Poisson's integral formula.

Note : Let $\frac{R^2 - r^2}{R^2 + r^2 - 2Rr \cos(\phi - \theta)} = P(R, r, \phi - \theta)$. Then,

the function $P(R, r, \phi - \theta)$ is called the Poisson Kernel. Hence we can write (29) in the form

$$u(r, \theta) = \frac{1}{2\pi} \int_0^{2\pi} P(R, r, \phi - \theta) u(R, \phi) d\phi \quad (30)$$

We can also get a formula similar to (29) for the imaginary part of $f(z)$ by equating the imaginary part in (28). The corresponding formula is

$$v(r, \theta) = \frac{1}{2\pi} \int_0^{2\pi} \frac{(R^2 - r^2)v(R, \phi)d\phi}{R^2 + r^2 - 2Rr \cos(\phi - \theta)} = \frac{1}{2\pi} \int_0^{2\pi} P(R, r, \phi - \theta)v(R, \phi) d\phi \quad (31)$$

Remark : Cauchy's integral formula expresses the values of an analytic function inside a circle in terms of its values on the boundary of the circle whereas Poisson's integral formula expresses the values of a harmonic function inside a circle in terms of its values on the boundary of the circle.

Result 3. $\frac{1}{2\pi} \int_0^{2\pi} P(R, r, \phi - \theta) d\phi = 1.$

Proof : By Poisson's integral formula we have,

$$u(r, \theta) = \frac{1}{2\pi} \int_0^{2\pi} P(R, r, \phi - \theta) u(R, \phi) d\phi \text{ Taking } u(r, \theta) \equiv 1 \text{ we get,}$$

$$\frac{1}{2\pi} \int_0^{2\pi} P(R, r, \phi - \theta) d\phi = 1$$

Result 4. $P(R, r, \phi - \theta) = \operatorname{Re} \left(\frac{\zeta + z}{\zeta - z} \right)$

Proof : Let $\zeta = Re^{i\phi}$, $z = re^{i\theta}$, $r < R$. Then,

$$\begin{aligned} \frac{\zeta + z}{\zeta - z} &= \frac{Re^{i\phi} + re^{i\theta}}{Re^{i\phi} - re^{i\theta}} = \frac{(R \cos \phi + r \cos \theta) + i(R \sin \phi + r \sin \theta)}{(R \cos \phi - r \cos \theta) + i(R \sin \phi - r \sin \theta)} \\ &= \frac{\{(R \cos \phi + r \cos \theta) + i(R \sin \phi + r \sin \theta)\} \{(R \cos \phi - r \cos \theta) - i(R \sin \phi - r \sin \theta)\}}{(R \cos \phi - r \cos \theta)^2 + (R \sin \phi - r \sin \theta)^2} \end{aligned}$$

Simplifying we get, $\operatorname{Re} \left(\frac{\zeta + z}{\zeta - z} \right) = \frac{R^2 - r^2}{R^2 + r^2 - 2Rr \cos(\phi - \theta)} = P(R, r, \phi - \theta).$

Result 5. Poisson Kernel $P(R, r, \phi - \theta)$ is harmonic in $|z| < R$.

Proof : Let $f(z) = \frac{\zeta + z}{\zeta - z}$. Then $f(z)$ is analytic in $|z| < R$. By result 4, $P(R, r, \phi - \theta) = \operatorname{Re} f(z)$. Hence the Poisson Kernel is the real part of an analytic function. Hence $P(R, r, \phi - \theta)$ is harmonic in $|z| < R$.

Note : We can easily show that $\frac{R^2 - r^2}{R^2 + r^2 - 2Rr \cos(\phi - \theta)} = \frac{R^2 - |z|^2}{|\operatorname{Re}^{i\phi} - z|^2}$

where $z = re^{i\theta}$, $r < R$. Hence $\operatorname{Re}\left(\frac{\zeta + z}{\zeta - z}\right) = \frac{R^2 - |z|^2}{|Re^{i\phi} - z|^2}$ and Poisson's integral formula (29) can be written as

$$u(r, \theta) = \frac{1}{2\pi} \int_0^{2\pi} \frac{R^2 - |z|^2}{|Re^{i\phi} - z|^2} u(R, \phi) d\phi \quad (32)$$

The function $\frac{R^2 - |z|^2}{|Re^{i\phi} - z|^2}$ is the Poisson Kernel.

Theorem 2.2 Let $u(x, y) \neq \text{constant}$ be harmonic on a simply connected domain D . Then $u(x, y)$ has neither a maximum nor a minimum at any point of D .

Proof. Let $z_0 = x_0 + iy_0$ be an arbitrary point of D . Then following theorem 2.1 there is an analytic function $f(z)$ in a neighbourhood $N(z_0)$ of z_0 such that $\operatorname{Re} f = u$. Then

$$g(z) = e^{f(z)}$$

is analytic on $N(z_0)$ and not equal to constant since $u(x, y) \neq \text{constant}$ and

$$|g(z)| = e^{u(x,y)}$$

Again exponential function is strictly increasing, so a maximum for u at (x_0, y_0) is also a maximum for e^u , and hence also a maximum of $|e^f|$ i.e. of $|g(z)|$ at z_0 . The function $u(x, y)$ cannot have a maximum at (x_0, y_0) , since otherwise $|g(z)|$ would have a maximum at z_0 , thereby contradicting the maximum modulus principle. Likewise, following the minimum modulus principle $|g(z)|$ cannot have a minimum value at z_0 since $|g(z)| \neq 0$ on D . Therefore $u(x, y)$ cannot possess minimum value at (x_0, y_0) .

Corollary. Let $u(x, y)$ be harmonic on a domain D and continuous on \bar{D} . Then $u(x, y)$ attains its maximum and its minimum on the boundary of D .

Proof. Since $u(x, y)$ is continuous on the compact set \bar{D} , it attains both its maximum and its minimum on \bar{D} , but $u(x, y)$ cannot possess a maximum or a minimum at a point of D . Therefore the corollary follows.

Example 2. Given $u(x, y)$ harmonic in the disk $|z| < R$ and $A(r_j)$ its maximum value on the circle $|z| = r_j$, $r_j < R$, $j = 1, 2, 3$. Prove that

$$A(r_2) \leq \frac{\log r_2 - \log r_1}{\log r_3 - \log r_1} A(r_3) + \frac{\log r_3 - \log r_2}{\log r_3 - \log r_1} A(r_1)$$

for $0 < r_1 < r_2 < r_3 < R$.

Solution. Since $u(x, y)$ is harmonic in $|z| < R$, $u(x, y) + \alpha \log r$, $r = \sqrt{x^2 + y^2}$, $\alpha \equiv a$ real constant to be fixed later, is also harmonic in the annulus $r_1 \leq |z| \leq r_3$. Hence its

maximum is attained on the boundary of the annulus i.e. on $|z| = r_1$ or, $|z| = r_3$ or, on both. Either $A(r_1) + \alpha \log r_1$ or, $A(r_3) + \alpha \log r_3$ is maximum. We define α so that

$$A(r_1) + \alpha \log r_1 = A(r_3) + \alpha \log r_3$$

$$\text{or, } \alpha = \frac{A(r_1) - A(r_3)}{\log r_3 - \log r_1}$$

The circle $|z| = r_2$ lies inside the annulus $r_1 \leq |z| \leq r_3$ and according to corollary of the theorem 2.2 regarding maximum value of the harmonic function $u(x, y) + \alpha \log r$ we have

$$A(r_2) + \alpha \log r_2 \leq A(r_3) + \alpha \log r_3$$

$$\text{or, } A(r_2) \leq A(r_3) + \alpha(\log r_3 - \log r_2)$$

$$= A(r_3) + \frac{A(r_1) - A(r_3)}{\log r_3 - \log r_1} (\log r_3 - \log r_2)$$

$$= \frac{\log r_2 - \log r_1}{\log r_3 - \log r_1} A(r_3) + \frac{\log r_3 - \log r_2}{\log r_3 - \log r_1} A(r_1)$$

2.4 The Dirichlet Problem

Let D be a domain with boundary Γ and let $\cup(x, y)$ be a continuous real function defined on Γ . The Dirichlet problem is to find a function $u(x, y)$, harmonic on D and continuous on \bar{D} , which coincides with $\cup(x, y)$ at every point of Γ .

Existence of a solution of Dirichlet's problem for a disc

Theorem 2.3 Let D be the disc $|z| < R$ with boundary $\Gamma : |z| = R$ and let $U(\phi)$ be a continuous real function on the interval $[0, 2\pi]$ such that $U(0) = U(2\pi)$. Then the function $u(r, \theta)$ defined by the integral

$$u(r, \theta) = \frac{1}{2\pi} \int_0^{2\pi} \frac{(R^2 - r^2)U(\phi)}{R^2 + r^2 - 2Rr \cos(\phi - \theta)} d\phi \quad (33)$$

$$\text{for any point } (r, \theta) \text{ on } D \text{ any by } u(R, \phi) = U(\phi) \quad (34)$$

for any point (R, ϕ) on Γ , solves the Dirichlet problem for the disc D . In otherwords,

(i) u is harmonic on D and continuous on \bar{D} and (ii) $\lim_{r \rightarrow R} u(r, \theta) = U(\phi_0)$,

where $Re^{i\phi_0}$ is any fixed point on Γ .

Proof : To prove that $u(r, \theta)$ defined by (33) on D is harmonic on D we observe that

$$\frac{R^2 - r^2}{R^2 + r^2 - 2Rr \cos(\phi - \theta)} = P(R, r, \phi - \theta)$$

$$= \operatorname{Re} \left(\frac{\zeta + z}{\zeta - z} \right), \text{ where } P(R, r, \phi - \theta) \text{ is the Poisson Kernel and } \zeta = Re^{i\phi}, z = re^{i\theta}, r < R.$$

The r.h.s. is the real part of the function $\frac{\zeta + z}{\zeta - z}$ which is analytic in D . Hence the Poisson Kernel $P(R, r, \phi - \theta)$ is harmonic in D . So, differentiation under the sign of integration is valid. Applying the Laplacian ∇^2 in (r, θ) to both sides of (33) we get,

$$\nabla^2 u = \frac{1}{2\pi} \int_0^{2\pi} U(\phi) \cdot \nabla^2 P(R, r, \phi - \theta) d\phi = 0 \quad [\text{Since } P(R, r, \phi - \theta)$$

is harmonic in $D \Rightarrow \nabla^2 P(R, r, \phi - \theta) = 0]$.

$\Rightarrow u$ is harmonic on D .

Next we prove that the function $u(r, \theta)$ defined by the integral (33) approaches $U(\phi_0)$ as the point (r, θ) in D tends to any fixed point (R, ϕ_0) on Γ .

Let (r_n, θ_n) be an arbitrary sequence of points in D converging to the boundary point (R, ϕ_0) . We now consider the difference

$$\begin{aligned} u(r_n, \theta_n) - U(\phi_0) &= \frac{1}{2\pi} \int_0^{2\pi} P(R, r_n, \phi - \theta_n) U(\phi) d\phi - U(\phi_0) \\ &= \frac{1}{2\pi} \int_0^{2\pi} \{U(\phi) - U(\phi_0)\} P(R, r_n, \phi - \theta_n) d\phi \end{aligned} \quad (35)$$

$$\left(\text{Since } \frac{1}{2\pi} \int_0^{2\pi} P(R, r_n, \phi - \theta_n) d\phi = 1 \right)$$

Since $U(\phi)$ is continuous on Γ , for given $\epsilon > 0$ there exists a $\delta(\epsilon) > 0$ such that

$$|U(\phi) - U(\phi_0)| < \frac{\epsilon}{2} \quad (36)$$

$$\text{whenever } |\phi - \phi_0| < 2\delta \quad (37)$$

we choose δ so small that (36) is satisfied and $\phi_0 - 2\delta > 0$, $\phi_0 + 2\delta < 2\pi$. We break the integral on r.h.s. of (35) as

$$\begin{aligned} |u(r_n, \theta_n) - U(\phi_0)| &\leq \left| \frac{1}{2\pi} \int_0^{\phi_0 - 2\delta} P(R, r_n, \phi - \theta_n) \{U(\phi) - U(\phi_0)\} d\phi \right| \\ &+ \left| \frac{1}{2\pi} \int_{\phi_0 - 2\delta}^{\phi_0 + 2\delta} \dots \right| + \left| \frac{1}{2\pi} \int_{\phi_0 + 2\delta}^{2\pi} \dots \right| = |I_1| + |I_2| + |I_3| \end{aligned} \quad (38)$$

Now,
$$|I_2| \leq \frac{1}{2\pi} \int_{\phi_0-2\delta}^{\phi_0+2\delta} |P(\mathbf{R}, r_n, \phi - \theta_n)| |U(\phi) - U(\phi_0)| d\phi$$

$$< \frac{\epsilon}{2} \cdot \frac{1}{2\pi} \int_0^{2\pi} |P(\mathbf{R}, r_n, \phi - \theta_n)| d\phi = \frac{\epsilon}{2}$$
 (39)

To estimate the other two terms we choose n so large that

$|\phi_0 - \theta_n| < \delta$. Then, $|\phi - \theta_n| = |\phi - \phi_0 + \phi_0 - \theta_n| \geq |\phi - \phi_0| - |\phi_0 - \theta_n| > 2\delta - \delta = \delta$ since $|\phi - \phi_0| > 2\delta$ whenever ϕ belongs to either of the intervals $[0, \phi_0 - 2\delta]$ or $[\phi_0 + 2\delta, 2\pi]$.

Then, $|I_1| + |I_3| \leq 2M \cdot \frac{1}{2\pi} \cdot \frac{R^2 - r_n^2}{R^2 + r_n^2 - 2Rr_n \cos \delta} \left(\int_0^{\phi_0-2\delta} d\phi + \int_{\phi_0+2\delta}^{2\pi} d\phi \right)$

$$< 2M \frac{R^2 - r_n^2}{R^2 + r_n^2 - 2Rr_n \cos \delta} \rightarrow 0 \text{ as } r_n \rightarrow R,$$

where $M = \text{Max}_{\phi \in [0, 2\pi]} |U(\phi) - U(\phi_0)|$ and $\cos(\phi - \theta_n) < \cos \delta$.

Thus, for sufficiently large n , $|I_1| + |I_3| < \frac{\epsilon}{2}$ (40)

Using (39) and (40) in (38) we get,

$|u(r_n, \theta_n) - U(\phi_0)| < \epsilon$ for sufficiently large n ;

i.e. $\lim_{n \rightarrow \infty} u(r_n, \theta_n) = U(\phi_0)$ (41)

where (r_n, θ_n) is an arbitrary sequence of points in D approaching (R, ϕ_0) .

Equation (41) still holds if some or all the points (r_n, θ_n) lie on Γ since in that case we can directly use the fact that $U(\phi)$ is continuous on Γ . This implies $u(r, \theta)$ is continuous on \bar{D} . This completes the proof.

Uniqueness of the solution to the Dirichlet problem for a disc.

Let u_1 and u_2 be two solutions of the Dirichlet problem. Then their difference $u_1 - u_2 = h$ is harmonic in D and continuous in the closed disk and takes the value zero on the boundary. Hence h attains its upper bounds at some points of the closed disk. If $l > 0$, the upper bound will occur in the open disk, since on the boundary Γ h is zero. This contradicts the conclusions of theorem 2.2. So then $l = 0$. In the same way we can show that the lower bound of h on \bar{D} is zero. Thus there is no alternative but h to be zero on \bar{D} .

Theorem 2.4 Any continuous function $u(z)$ possessing the mean-value property in a domain D is harmonic in D .

Proof. Let \bar{K} be a closed disk contained in D . By hypothesis of the theorem u satisfies the mean value property in K . We shall prove that u is harmonic in K . By the theorem 2.3 on the Dirichlet problem for a disk there exists a continuous function $\tilde{u}(z)$ in K , which is harmonic in the interior of K and coincides with $u(z)$ on the boundary of K . The difference $u - \tilde{u}$ is continuous and satisfies the mean-value property in K . By the corollary to the theorem 3.7 [(14) page-58] $u - \tilde{u}$ satisfies the maximum modulus principle in K . Now as $u - \tilde{u}$ is zero on the boundary of K , it will be identically zero in K . Therefore u coincides with the harmonic function \tilde{u} in the interior of K and since K is arbitrary, u is harmonic in the domain D .

The Harnack Inequality : Let u be a non-negative Harmonic function on a closed disk $\bar{D}(0, R)$. Then, for any point $z \in D(0, R)$

$$\frac{R - |z|}{R + |z|} u(0) \leq u(z) \leq \frac{R + |z|}{R - |z|} u(0) \quad (42)$$

where $D(0, R)$ denotes a disk with centre 0 and radius R .

Proof. From the Poisson's integral formula for u on $\bar{D}(0, R)$:

$$u(z) = \frac{1}{2\pi} \int_0^{2\pi} u(Re^{i\phi}) \frac{R^2 - |z|^2}{|Re^{i\phi} - z|^2} d\phi$$

Now,
$$\frac{R^2 - |z|^2}{|Re^{i\phi} - z|^2} \leq \frac{R^2 - |z|^2}{(R - |z|)^2} = \frac{R + |z|}{R - |z|}$$

Combining these two, we see that

$$u(z) \leq \frac{R + |z|}{R - |z|} \frac{1}{2\pi} \int_0^{2\pi} u(Re^{i\phi}) d\phi = \frac{R + |z|}{R - |z|} u(0),$$

where we make use of the mean value theorem. Similarly, the other inequality in

(42) will follow from
$$\frac{R^2 - |z|^2}{|Re^{i\phi} - z|^2} \geq \frac{R^2 - |z|^2}{(R + |z|)^2} = \frac{R - |z|}{R + |z|}$$

Corollary Let u be a non-negative harmonic function on a closed disk $\bar{D}(\zeta, R)$. Then for any $z \in D(\zeta, R)$,

$$\frac{R - |z - \zeta|}{R + |z - \zeta|} u(\zeta) \leq u(z) \leq \frac{R + |z - \zeta|}{R - |z - \zeta|} u(\zeta) \quad (43)$$

2.5 Subharmonic & Superharmonic Functions

Definition : A real-valued continuous function $u(x, y)$ in an open set D of the complex plane \mathcal{C} is said to be

(i) subharmonic if, for any $\zeta \in D$

$$u(\zeta) \leq \frac{1}{2\pi} \int_0^{2\pi} u(\zeta + re^{i\theta}) d\theta$$

hold for sufficiently small $r > 0$.

(ii) superharmonic if, for any $a \in D$

$$u(a) \geq \frac{1}{2\pi} \int_0^{2\pi} u(a + re^{i\theta}) d\theta$$

hold for sufficiently small $r > 0$.

From the definition it follows that every harmonic function is subharmonic as well as superharmonic.

Example 3. If $f(z)$ is analytic on a domain D , then $|f(z)|$ is subharmonic but not harmonic in D unless $f(z) \equiv \text{constant}$.

Solution : Using the Cauchy's integral formula

$$|f(a)| \leq \frac{1}{2\pi} \int_0^{2\pi} |f(a + re^{i\theta})| d\theta \quad (44)$$

for every $a \in D$ and $r (> 0)$ is small enough. Here equality holds only if $f(z) \equiv \text{constant}$. We now show that the integral

$$I(r) = \frac{1}{2\pi} \int_0^{2\pi} |f(a + re^{i\theta})| d\theta$$

is a strictly increasing function of r , if $f(z) \neq \text{constant}$. Let $0 < r_1 < r_2 < k(a)$ and $g(\theta)$ be continuous on $[0, 2\pi]$ and $F(z)$ be defined by

$$(i) \quad g(\theta)f(a + r_1e^{i\theta}) = |f(a + r_1e^{i\theta})|, 0 \leq \theta \leq 2\pi$$

$$(ii) \quad F(z) = \frac{1}{2\pi} \int_0^{2\pi} f(a + ze^{i\theta}) g(\theta) d\theta, |z| \leq r_2$$

(iii) $k(a) \equiv \text{minmum distance between } a \text{ and the boundary of } D$.

$F(z)$ is regular for $|z| \leq r_2$ and attains its maximum of the boundary of the disc, say at $z = r_2e^{i\phi}$. Then

$$\begin{aligned} I(r_1) &= \frac{1}{2\pi} \int_0^{2\pi} |f(a + r_1e^{i\theta})| d\theta \\ &= \frac{1}{2\pi} \int_0^{2\pi} f(a + r_1e^{i\theta}) g(\theta) d\theta \end{aligned}$$

$$\begin{aligned}
&= F(r_1) \\
&< |F(r_2 e^{i\theta})| \\
&\leq \frac{1}{2\pi} \int_0^{2\pi} |f(a + r_2 e^{i(\theta+\phi)})| d\theta \\
&= \frac{1}{2\pi} \int_\phi^{2\pi+\phi} |f(a + r_2 e^{i\psi})| d\psi, \text{ taking } \phi + \theta = \psi \\
&= \frac{1}{2\pi} \left\{ \int_0^{2\pi} - \int_0^\phi + \int_{2\pi}^{2\pi+\phi} |f(a + r_2 e^{i\psi})| d\psi \right\} \\
&= \frac{1}{2\pi} \int_0^{2\pi} |f(a + r_2 e^{i\psi})| d\psi, \text{ (substituting } \psi = 2\pi + \theta \text{ in the third}
\end{aligned}$$

integral, we find that it cancels the second term)

$= I(r_2)$. Hence equality in (44) is possible if and only if $f(z) \equiv \text{constant}$. Therefore $|f(z)|$ is subharmonic but not harmonic in D unless $f(z) \equiv \text{constant}$.

Example 4. If $f(z) \neq 0$ is analytic in a domain D , then $\log |f(z)|$ is subharmonic in D .

Solution : Let $\Phi(z) = \log |f(z)|$. Here at the zeros of $f(z)$, $\Phi(z)$ has poles and takes the value $-\infty$ there. In every closed disk contained in D there are at most a finite number of points where $\log |f(z)| = -\infty$.

Now let $a \in D$ be any point at which $f(z)$ is distinct from zero. Since $f(z)$ is analytic and not identically zero, there exists a small neighbourhood of a where $f(z)$ is distinct from zero. We find that

$$\log f(z) = \log |f(z)| + i \arg f(z)$$

is analytic in this neighbourhood and hence $\log |f(z)|$ is harmonic there and we have the equality

$$\Phi(a) = \frac{1}{2\pi} \int_0^{2\pi} \Phi(a + re^{i\theta}) d\theta \quad (45)$$

for all sufficiently small values of r . On the otherhand, if a is a zero of $f(z)$, we have

$$\Phi(a) = -\infty < \frac{1}{2\pi} \int_0^{2\pi} \Phi(a + re^{i\theta}) d\theta \quad (46)$$

Combining (45) with (46) we obtain $\Phi(z)$ is subharmonic in D .

Unit 3 □ Conformal Mappings

Structure

3.0 Objectives of this Chapter

3.1 Conformal Mappings

3.2 Basic Properties of Conformal Mapping

3.0 Objectives of this Chapter

This chapter deals with conformal mappings and their basic properties. Many examples are given to explain different concepts on conformal mappings. The inverse function theorem is also discussed.

3.1 Conformal Mappings

Let X be an open set in \mathcal{C} and suppose a function $f : X \rightarrow \mathcal{C}$ is given. We know from functional analysis that if f is continuous, a compact set of X is mapped onto a compact set in $f(X)$ and a connected set of X onto a connected set of $f(X)$. If moreover, f is single-valued and analytic there occur several interesting results. In this chapter we study mappings which transform different curves and regions from one complex plane to other complex plane with reference to magnitude and orientation. Such type of mappings play an important role in the study of various physical problems defined on domains and curves of arbitrary shape.

Level Curves

Let $w = f(z)$ with $z = x + iy$ and $w = u + iv$ where $f(z)$ is analytic. $u = u(x, y)$ $v = v(x, y)$ satisfy Cauchy-Riemann equations

$$u_x = v_y, u_y = -v_x$$

from which it follows that

$$u_{xx} + u_{yy} = 0$$

$$v_{xx} = v_{yy} = 0$$

Also, $\nabla_u \cdot \nabla_v = 0$, where

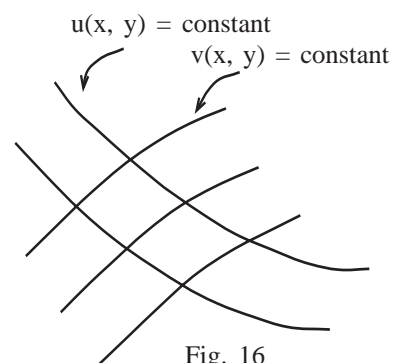

Fig. 16

$$\nabla = \left(\frac{\partial}{\partial x}, \frac{\partial}{\partial y} \right)$$

So that the level curves $u(x, y) = \text{constant}$ and $v(x, y) = \text{constant}$ are orthogonal.

$$\text{Now } f^1(z) = u_x + iv_x = u_x - iu_y = v_y + iv_x$$

$$\text{so that } |f^1(z)|^2 = u_x^2 + u_y^2 = v_x^2 + v_y^2.$$

Two basic results :

No. 1

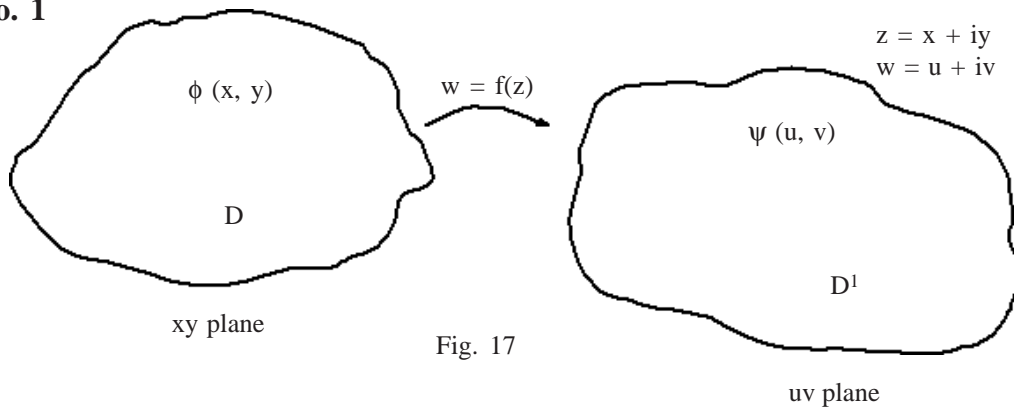

Fig. 17

Suppose that $w = f(z)$ maps D into D^1 .

Let $\psi(u, v) = \psi((u(x, y), v(x, y))) = \phi(x, y)$.

To prove $\phi_{xx} + \phi_{yy} = |f^1(z)|^2 (\psi_{uu} + \psi_{vv})$

we calculate

$$\begin{aligned} \phi_x &= \psi_u u_x + \psi_v v_x \\ \phi_{xx} &= \psi_{uu} u_x^2 + \psi_{vv} v_x^2 + 2\psi_{uv} u_x v_x + \psi_u u_{xx} + \psi_v v_{xx} \\ \phi_{yy} &= \psi_{uu} u_y^2 + \psi_{vv} v_y^2 + 2\psi_{uv} u_y v_y + \psi_u u_{yy} + \psi_v v_{yy} \end{aligned}$$

Thus, $\phi_{xx} + \phi_{yy} = (u_x^2 + u_y^2)\psi_{uu} + (v_x^2 + v_y^2)\psi_{vv} + 2\psi_{uv} \nabla_u \cdot \nabla_v$,

since u, v satisfy Laplace equation. Again, $\nabla_u \cdot \nabla_v = 0$,

so we obtain $\phi_{xx} + \phi_{yy} = |f^1(z)|^2 (\psi_{uu} + \psi_{vv})$

Therefore if $f^1(z) \neq 0$ inside D we have $\phi_{xx} + \phi_{yy} = 0$ implies $\psi_{uu} + \psi_{vv} = 0$ and vice-versa.

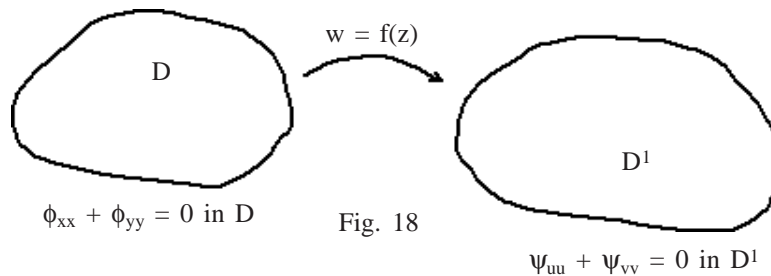

Fig. 18

No. 2. Consider a level curve $F(x, y) = 0$ upon $\nabla\phi \cdot \underline{n} = 0$.

Let under the analytic mapping $w = f(z)$ the level curve map to $G(u, v) = 0$.

We shall show that $\nabla\psi \cdot \underline{n} = 0$ on $G(u, v) = 0$

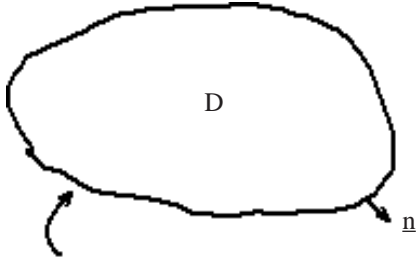

Fig. 19

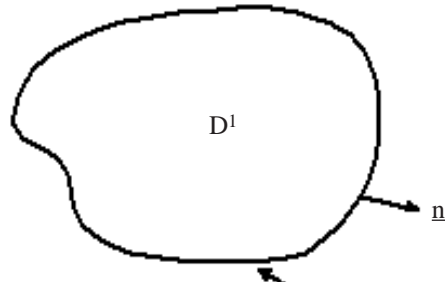

Fig. 20

Consider the map $w = f(z) \rightarrow \omega = u + iv$, so $u = u(x, y)$, $v = v(x, y)$.

Suppose $f(z)$ is analytic. Then,

$$\left. \begin{aligned} \phi_x &= \psi_u u_x + \psi_v v_x \\ \phi_y &= \psi_u u_y + \psi_v v_y \end{aligned} \right\} \text{ so, } \begin{pmatrix} \phi_x \\ \phi_y \end{pmatrix} = S \begin{pmatrix} \psi_u \\ \psi_v \end{pmatrix} \text{ with } S = \begin{pmatrix} u_x & v_x \\ u_y & v_y \end{pmatrix}$$

Then, $\nabla\phi = S\nabla\psi$, $\nabla F = S\nabla G$ and clearly, $S^T S = |f^1(z)|^2 \mathbf{1}$

$$\text{Now, } \frac{\partial\phi}{\partial\underline{n}} = \nabla\phi \cdot \frac{\nabla F}{|\nabla F|} = \frac{S\nabla\psi \cdot (S\nabla G)}{|S\nabla G|} = \frac{(\nabla\psi)^T S^T S \nabla G}{\{(S\nabla G)^T (S\nabla G)\}^{1/2}} = \frac{(\nabla\psi)^T \nabla G |f^1(z)|}{\{(\nabla G)^T \nabla G\}^{1/2}}$$

(where the usual vector operations, $\underline{a} \cdot \underline{b} = \mathbf{a}^T \mathbf{b}$ and $(\mathbf{a} \cdot \mathbf{a})^{1/2} = (\mathbf{a}^T \mathbf{a})^{1/2} = |\mathbf{a}|$ have been used)

$$\text{So, } \frac{\partial\phi}{\partial\underline{n}} = \nabla\phi \cdot \frac{\nabla F}{|\nabla F|} = |f^1(z)| \nabla\psi \cdot \frac{\nabla G}{|\nabla G|} = |f^1(z)| \frac{\partial\psi}{\partial\underline{n}}$$

This shows that if $\frac{\partial\phi}{\partial\underline{n}} = 0$ on the boundary of D then $\frac{\partial\psi}{\partial\underline{n}} = 0$ on the boundary

of D^1 , provided $|f^1(z)| \neq 0$ on the boundary of D .

Note : These give us a means of transforming the domain over which the Laplace's equation is to be solved comfortably. Such type of things is usually dealt in solving boundary value problems in potential theory.

Angle of Rotation

Given a function of a complex variable $w = f(z)$ analytic in a domain D . Let z_0 be any point lying within D , $\gamma : z = \sigma(t)$, $a \leq t \leq b$, $\sigma(t_0) = z_0$, be a curve passing

through z_0 (and lying within D). The function $\sigma(t)$ has a non zero derivative $\sigma'(t_0)$ at the point z_0 and the curve γ has a tangent at this point with a slope equal to $\text{Arg } \sigma'(t_0)$.

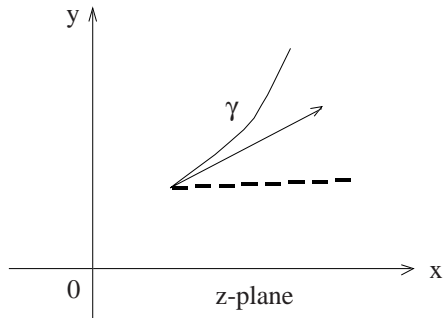

Fig. 21

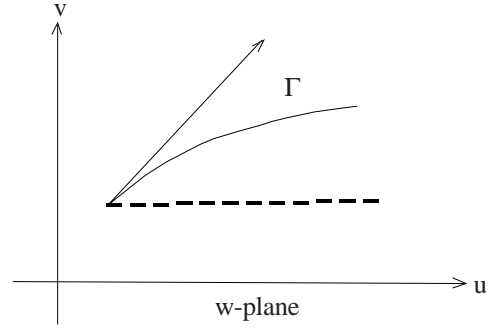

Fig. 22

Under the mapping $w = f(z)$ the curve γ is transformed into a curve $\Gamma : w = f(\sigma(t)) = \mu(t)$, $a \leq t \leq b$, $\mu(t_0) = f(z_0) = w_0$ in the w -plane. $\mu(t)$ is differentiable at $t = t_0$ and the curve Γ has a tangent at $w_0 = f(z_0)$. Then following the chain rule for differentiation of composite functions, assuming $f'(z_0) \neq 0$

$$\mu'(t_0) = f'(\sigma(t_0)) \sigma'(t_0)$$

It follows that

$$\text{Arg } \mu'(t_0) = \text{Arg } f'(z_0) + \text{Arg } \sigma'(t_0)$$

$$\text{i.e.,} \quad \text{Arg } \mu'(t_0) = \text{Arg } \sigma'(t_0) + \text{Arg } f'(z_0) \quad (47)$$

This implies that change in slope of a curve at a point under a transformation depends only on the point and not on the particular curve through that point.

Example 1. Verify the result given in equation (47) for the curve $y = x^2$ under the transformation $f(z) = z^2$ at $z = 1 + i$.

Solution. First we calculate the change in slope of the curve $y = x^2$ at the given point under the transformation $w \equiv f(z) = z^2$. Following the formula given in eq. (47)

$$\text{Arg } f'(1 + i) = \text{Arg } 2(1 + i) = \tan^{-1} 1$$

A parametric form of the given curve $y = x^2$ is given by

$$\gamma : z = t + it^2, \quad -\infty < t < \infty.$$

Here $z_0 = 1 + i$ at $t_0 = 1$ and $z'(1) = 1 + 2i$, so that slope of the curve γ is $\tan^{-1} 2$.

Now we find slope of the transformed curve.

$$w = f(z) \Rightarrow u + iv = (x + iy)^2$$

So, $u = x^2 - y^2$ and $v = 2xy = 2x \cdot x^2 = 2x^3$.

Then, $u = x^2 - x^4 = \left(\frac{v}{2}\right)^{2/3} - \left(\frac{v}{2}\right)^{4/3}$, which is the equation of the transformed curve Γ . The image of the point $(1 + i)$ of z -plane is the point $2i$ in the w -plane and the slope of the curve Γ at $w = 2i$ is

$$\left. \frac{dv}{du} \right|_{w=2i} = -3$$

Thus the change in slope of the curve γ under the transformation is

$$\tan^{-1}(-3) - \tan^{-1}(2) = \tan^{-1} \frac{-3-2}{1-6} = \tan^{-1} 1$$

which is the same as obtained earlier following equation (47).

Definition : A mapping $w = f(z)$ is said to be conformal at a point $z = z_0$, if it preserves angles between oriented curves, passing through z_0 , in magnitude and in sense of rotation.

Theorem 3.1 : Let $f(z)$ be an analytic function in a domain D containing z_0 .

If $f'(z_0) \neq 0$, then $f(z)$ is conformal at z_0 .

Proof. Let $C_1 : z = z_1(t)$ and $C_2 : z = z_2(t)$, $t \equiv$ parameter, be two curves which intersect at some $t = t_0$ where $z_1(t_0) = z_2(t_0) = z_0$, C_1^1, C_2^1 are their images under the mapping $w = f(z)$.

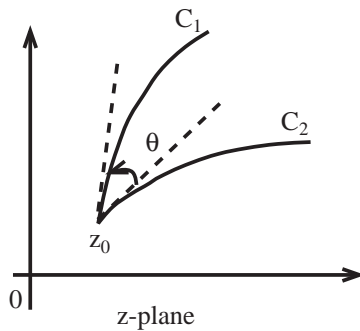

Fig. 21

tangent lines are

$$z^1 = z_1^1(t_0), \quad z^2 = z_2^1(t_0) \text{ at } t = t_0$$

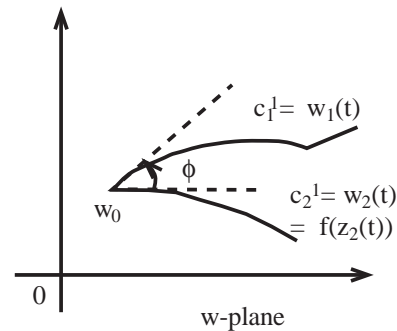

Fig. 22

tangent lines are

$$w_1^1(t_0) = f^1(z_1(t_0))z_1^1(t_0)$$

$$w_2^1(t_0) = f^1(z_2(t_0))z_2^1(t_0)$$

Then following the result given in eq. (47)

$$\text{Arg}(w_1^1(t_0)) - \text{Arg}(z_1^1(t_0)) = \text{Arg}(f^1(z_1(t_0))) = \text{Arg}(f^1 z_0)$$

and

$$\text{Arg}(w_2^1(t_0)) - \text{Arg}(z_2^1(t_0)) = \text{Arg}(f^1(z_2(t_0))) = \text{Arg}(f^1 z_0).$$

$$\text{Subtracting, } \text{Arg}(w_1^1(t_0)) - \text{Arg}(w_2^1(t_0)) - \{ \text{Arg}(z_1^1(t_0)) - \text{Arg}(z_2^1(t_0)) \} = 0$$

i.e., $\theta = \phi$, where $\theta = \text{angle between the curves } C_1 \text{ and } C_2 \text{ at } z_0$ and $\phi = \text{angle between the curves } C_1^1 \text{ and } C_2^1 \text{ at } w_0$.

Observation : From the basic results proved earlier we learn that if f is a conformal mapping, then orthogonal curves are mapped onto orthogonal curves.

3.2 Basic Properties of conformal Mappings

Let $f(z)$ be an analytic function in a domain D , and let z_0 be a point in D . If $f(z_0) = 0$, then we can express $f(z)$ in the form

$$f(z) = f(z_0) + (z - z_0)f^1(z_0) + (z - z_0)\eta(z),$$

where $\eta(z) \rightarrow 0$ as $z \rightarrow z_0$. If z is near z_0 , then the transformation $w = f(z)$ has the linear approximation

$$G(z) = A + B(z - z_0).$$

where $A = f(z_0)$ and $B = f^1(z_0)$. As $\eta(z) \rightarrow 0$ when $z \rightarrow z_0$, for points near z_0 the transformation $w = f(z)$ has an effect much like the linear mapping $w = G(z)$. The effect of the linear mapping G is a rotation of the plane through the angle $\alpha = \text{Arg}(f^1(z_0))$, followed by a magnification by the factor $|f^1(z_0)|$, followed by a translation by the vector $A + Bz_0$.

Remark : If $f^1(z_0) = 0$, the angle may not be preserved.

Let us consider, $w = f(z) = z^2$, then we have $f^1(0) = 0$ and

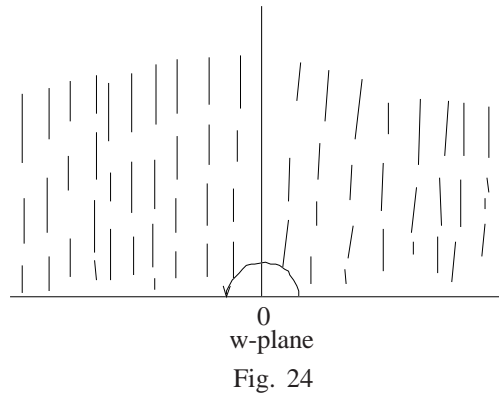
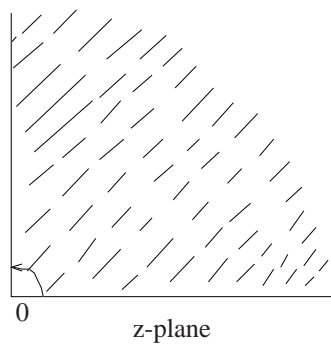

the angle at $z = 0$ is not preserved but is doubled.

Definition : Let $f(z)$ be a nonconstant analytic function. If $f^1(z_0) = 0$, the z_0 is called a critical point of $f(z)$, and the mapping $w = f(z)$ is not conformal at z_0 . We shall see afterwards what happens at a critical point.

The Inverse Function theorem 3.2 Let $f(z)$ be analytic at z_0 and $f'(z_0) \neq 0$. Then there exists a neighbourhood $N(w_0, \epsilon)$ of $w_0 = f(z_0)$ in which the inverse function $z = F(w)$ exists and is analytic.

$$\text{Moreover, } F'(w_0) = 1/f'(z_0). \quad (48)$$

Proof : Given $w = f(z)$, ($z = x + iy$, $w = u + iv$)

is analytic in a neighbourhood of z_0 , $K : |z - z_0| < \rho$. We shall show that for each $w \in L : |w - w_0| < \epsilon$ there is a unique solution $z = F(w)$, where $z \in K$.

We express the mapping $w = f(z)$ in terms of the set of equations

$$u = u(x, y) \text{ and } v = v(x, y) \quad (49)$$

which represents a transformation from the xy plane to the uv plane, u, v , possess continuous first-order partial derivatives satisfying C-R equations. The Jacobian determinant $J(x, y)$, is defined by

$$J(x, y) = \begin{vmatrix} u_x & u_y \\ v_x & v_y \end{vmatrix} \quad (50)$$

The transformation in equations (49) has a local inverse in L provided $J(x, y) \neq 0$ in K [(3) pp. 358-361]. Expanding r.h.s. of equation (50) and using the C-R equations, we obtain

$$\begin{aligned} J(x_0, y_0) &= u_x^2(x_0, y_0) + v_x^2(x_0, y_0) \\ &= |f'(z_0)|^2 \\ &\neq 0, \text{ by the given hypothesis.} \end{aligned} \quad (51)$$

Utilising the continuity of $J(x, y)$ in a small neighbourhood of (x_0, y_0) , equations (49) and (51) imply that a local inverse $z = F(w)$ exists in a neighbourhood of the point $w_0 = f(z_0)$. The derivative of $F(w)$ is given by the familiar expression

$$\begin{aligned} F'(w) &= \lim_{\Delta w \rightarrow 0} \frac{F(w + \Delta w) - F(w)}{\Delta w} = \lim_{\Delta w \rightarrow 0} \frac{\Delta z}{\Delta w} = \lim_{\Delta z \rightarrow 0} \frac{\Delta z}{f(z + \Delta z) - f(z)} \\ &= \lim_{\Delta z \rightarrow 0} 1 / \left(\frac{f(z + \Delta z) - f(z)}{\Delta z} \right) = 1 / \left(\lim_{\Delta z \rightarrow 0} \frac{f(z + \Delta z) - f(z)}{\Delta z} \right) \end{aligned}$$

$$\text{i.e., } F'(w) = \frac{1}{f'(z)}$$

holds in a neighbourhood of the point w_0 , as $f(z)$ is analytic in K .

$$\text{In particular, } F'(w_0) = \frac{1}{f'(z_0)}$$

Theorem 3.3 Let $f(z)$ be analytic at the point z_0 . If $f'(z_0) = 0$, $f''(z_0) = 0$, ...,

$f^{(k-1)}(z_0) = 0$ and $f^{(k)}(z_0) \neq 0$, then the mapping $w = f(z)$ magnifies angles at z_0 by k times.

Proof. By the given hypothesis, $f(z)$ has the Taylor expansion in a neighbourhood of z_0 in the form

$$f(z) = f(z_0) + c_k(z - z_0)^k + c_{k+1}(z - z_0)^{k+1} + \dots, \quad c_k \neq 0$$

so that we can express

$$f(z) - f(z_0) = (z - z_0)^k + h(z) \quad (52)$$

where $h(z)$ is analytic at z_0 and $h(z_0) \neq 0$. Now let $w = f(z)$ and $w_0 = f(z_0)$ and we obtain from (52)

$$\text{Arg}(w - w_0) = k \text{Arg}(z - z_0) + \text{Arg}(h(z))$$

Let $z \rightarrow z_0$ along a curve γ . Then $w \rightarrow w_0$ along the image curve Γ and the slope of tangent to the curve γ at z_0 and that of the tangent to the curve Γ at w_0 are connected by the relation

$$\lim_{w \rightarrow w_0} \text{Arg}(w - w_0) = k \lim_{z \rightarrow z_0} \text{Arg}(z - z_0) + \lim_{z \rightarrow z_0} \text{Arg}(h(z))$$

i.e.,
$$\theta_0 = k\phi_0 + \text{Arg}(h(z))$$

Thus, if γ_1 and γ_2 be two curves passing through z_0 and their images Γ_1 and Γ_2 under the mapping $w = f(z)$, pass through w_0 , the difference of slopes of the curves γ_1 and γ_2 at z_0 and that of the curves Γ_1 and Γ_2 at w_0 are related as

$$\theta_2 - \theta_1 = k(\phi_2 - \phi_1)$$

with the sense remain unchanged.

Example 2. Show that the mapping $w = f(z) = z^2$ maps the rectangle

$R = \left\{ x + iy : -1 \leq x \leq 1, 0 \leq y \leq \frac{1}{2} \right\}$ of unit area onto the region enclosed by the parabolas

$$v^2 = u + \frac{1}{4} \quad \text{and} \quad v^2 = -4(u - 1).$$

Solution : Here $f'(z) = 2z$ and the mapping $w = z^2$ is conformal for all $z \neq 0$. We note that the right angles at the vertices $z_1 = 1$, $z_2 = 1 + i/2$, $z_3 = -1 + i/2$ and $z_4 = -1$ are mapped into right angles at the vertices $w_1 = 1$, $w_2 = \frac{3}{4} + i$, $w_3 = \frac{3}{4} - i$ and $w_4 = 1$ respectively.

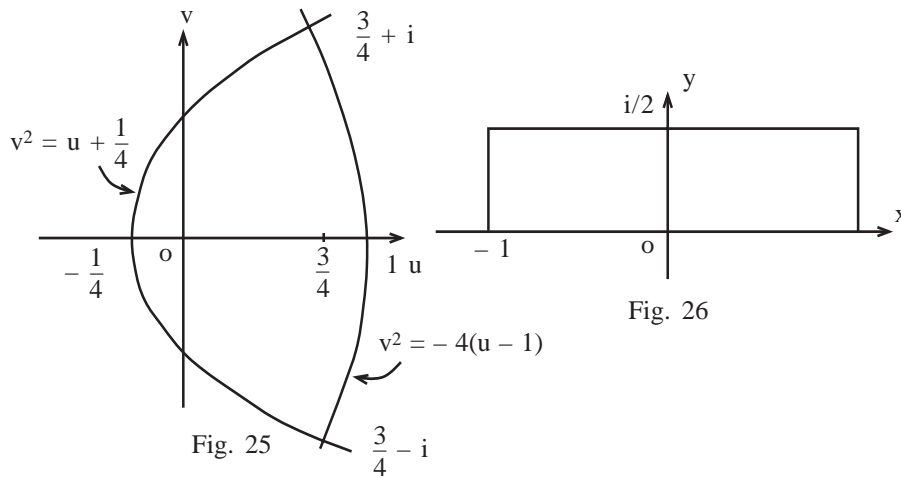

The parabolas shown in the figure are obtained as follows :

$$\text{Let } w = u + iv. \text{ Then } u = x^2 - y^2, v = 2xy \dots \quad (53)$$

The line $x = 1$ corresponds to the curve $u = 1 - y^2, v = 2y$. Eliminating y , we get $v^2 = -4(u - 1)$, which is a parabola with vertex $(1, 0)$ and opens towards the negative side of the u -axis in the w -plane. Also, the part of the line $x = 1$ lying above the real axis corresponds to the part of the parabola lying above the u -axis in the w -plane. The same parabola in the w -plane is the image of the line $x = -1$. In this case, the part of the line $x = -1$ lying above the real axis corresponds to the part of the parabola lying below the u -axis in the w -plane.

Again, when $y = \frac{1}{2}$, from (53) we get $u = x^2 - \frac{1}{4}$ and $v = x$. Eliminating x we get, $v^2 = u + \frac{1}{4}$ which is also a parabola with vertex $\left(-\frac{1}{4}, 0\right)$ and opening towards the positive side of the u -axis in the w -plane. By similar argument as before we can say that the mapping $w = z^2$ maps the rectangle $R = \left\{x + iy: -1 \leq x \leq 1, 0 \leq y \leq \frac{1}{2}\right\}$ onto the region enclosed by the parabolas $v^2 = u + \frac{1}{4}$ and $v^2 = -4(u - 1)$.

Note : It is not hard to prove that the parabolas intersect each other orthogonally at w_2 and w_3 .

At the point $z_0 = 0$, we have $f'(z_0) = f'(0) = 0$ and $f''(z_0) = 2 \neq 0$. Hence the angles at the origin $z_0 = 0$ are magnified by the factor $k = 2$. In particular the straight angle at $z_0 = 0$ is mapped onto 2π angle at $w_0 = 0$.

Unit 4 □ Multi-valued functions and Riemann Surface

Structure

- 4.0 Objectives of this Chapter
- 4.1 Multi-valued functions
- 4.2 The logarithm function
- 4.3 Properties of $\log z$
- 4.4 Branch, Branch point and Branch cut
- 4.5 Integrals of Multi-valued function
- 4.6 Branch points at infinity
- 4.7 Detection of branch points
- 4.8 The Riemann Surface for $w = z^{1/2}$
- 4.9 Concept of neighbourhood
- 4.10 The Riemann Surface for $w = \log z$
- 4.11 The Inverse Trigonometric Functions

4.0 Objectives of this Chapter

In this chapter we shall study multi-valued functions and their Riemann surfaces. In particular, multi-valued logarithm function, the power function z^α both z , α complex numbers, $z \neq 0$ will be discussed. The ideas of branch, branch point, branch cut, branch point at infinity will be explained by means of different examples. A few contour integrations of multi-valued functions will be performed. Also Riemann surfaces for different multi-valued functions will be constructed.

4.1 Multi-valued functions

So far we have considered single-valued functions i.e., one-to-one mapping or, many-to-one mapping. In the later case, under certain restrictions, inverse mappings give rise to multi-valued functions i.e., one-to-many.

For example,

$$z = e^{\omega}, z = \omega^2, z = \sin \omega, z = \cos \omega$$

For each of these functions, a given value of z corresponds to more than one value of ω .

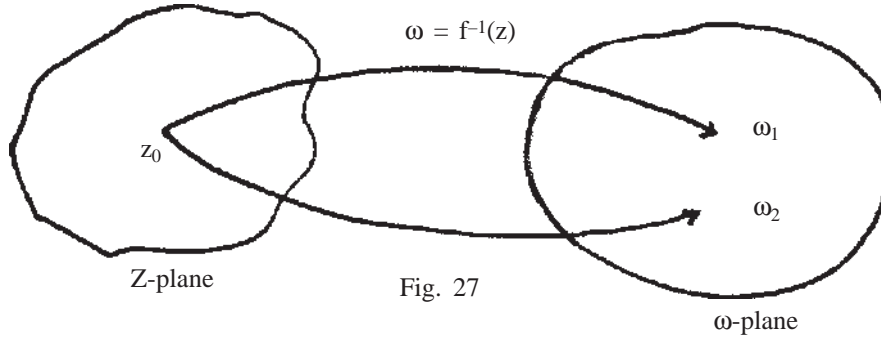

$\omega = f^{-1}(z)$ is multi-valued and $z = f(\omega)$ is single-valued, given ω , there is a unique value of z .

The aim of this chapter is as follows :

(i) To determine all possible values of the inverse function ω and (ii) To construct an inverse function which is single-valued in some region of the complex plane.

Let $\omega = f(z)$ be a multi-valued function. A branch of f is any single-valued function f_0 that is continuous in some domain (except, perhaps, on the boundary). At each point z in the domain, it assigns one of the values of $f(z)$.

Example 1 : We consider branches of the two-valued square-root function $f(z) = z^{1/2} (z \neq 0)$. The principal branch of the square root function is

$$f_1(z) = |z|^{1/2} e^{i\theta/2} = r^{1/2} \left(\cos \frac{\theta}{2} + i \sin \frac{\theta}{2} \right), \theta = \text{Arg}(z)$$

where $r = |z|$ and $-\pi < \theta \leq \pi$. The function f_1 is a branch of f . Using the same notation, we can find other branches of the function f . For example if we let

$$f_2(z) = |z|^{1/2} e^{i(\theta+2\pi)/2} = r^{1/2} \left[\cos \left(\frac{\theta+2\pi}{2} \right) + i \sin \left(\frac{\theta+2\pi}{2} \right) \right]$$

then

$$f_2(z) = r^{1/2} e^{i(\theta+2\pi)/2} = r^{1/2} e^{i\theta/2} \cdot e^{i\pi} = -f_1(z).$$

So, f_1 and f_2 can be taken as the two branches of the multi-valued square root function. The negative real axis is called a branch cut for the functions f_1 and f_2 . Each point on the branch cut is a point of discontinuity for both functions f_1 and f_2 .

Result 1 : Show that the function f_1 is discontinuous on the negative real axis.

Solution : Let $z_0 = r_0 e^{i\pi}$ be any point on the negative real axis. We compute the limit as z approaches z_0 through the upper half plane $\text{Im } z > 0$ and the limit as z approaches z_0 through the lower half plane $\text{Im } z < 0$. The limits are

$$\lim_{(r, \theta) \rightarrow (r_0, \pi)} f_1(re^{i\theta}) = \lim_{(r, \theta) \rightarrow (r_0, \pi)} r^{1/2} \left[\cos \frac{\theta}{2} + i \sin \frac{\theta}{2} \right] = ir_0^{1/2}, \text{ and}$$

$$\lim_{(r, \theta) \rightarrow (r_0, -\pi)} f_1(re^{i\theta}) = \lim_{(r, \theta) \rightarrow (r_0, -\pi)} r^{1/2} \left[\cos \frac{\theta}{2} + i \sin \frac{\theta}{2} \right] = -ir_0^{1/2}$$

The two limits are distinct, so the function f_1 is discontinuous at z_0 . Since z_0 is an arbitrary point on the negative real axis, f_1 is discontinuous there.

Note : Likewise, f_2 is discontinuous at z_0 .

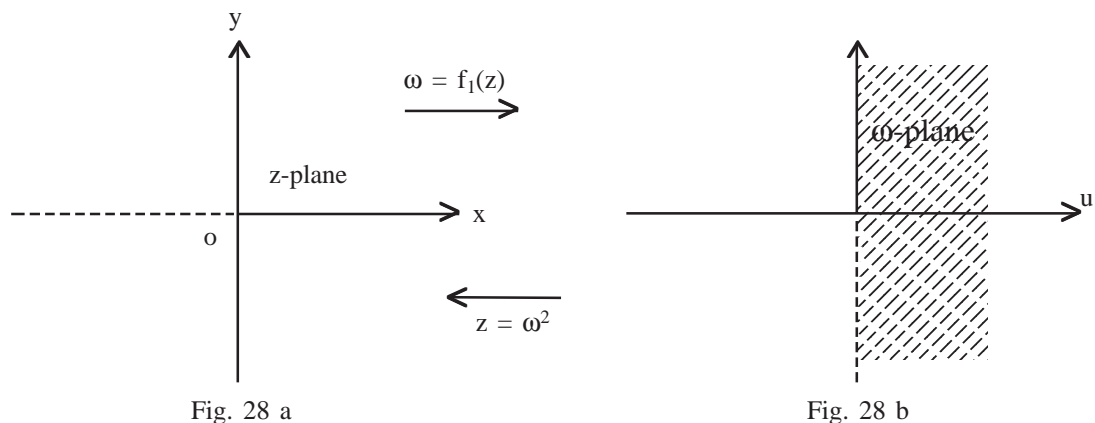

Fig. 28 a

Fig. 28 b

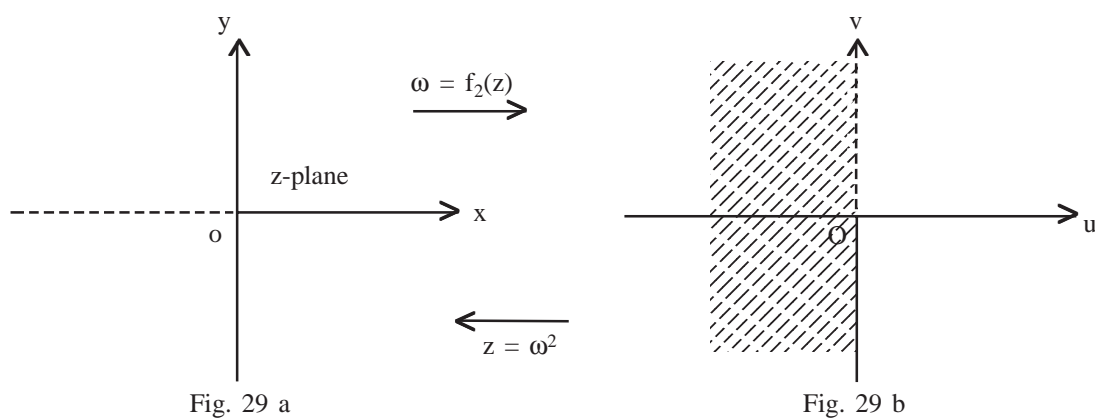

Fig. 29 a

Fig. 29 b

Figures : 28-29 The Branches f_1 and f_2 of $f(z) = z^{1/2}$

4.2 The logarithm function

Let us define the inverse function $f^{-1}(z)$ for $z = e^\omega$: Let $z = re^{i\theta}$ and $\omega = u + iv$.
Then $re^{i\theta} = e^u \cdot e^{iv}$

So that $r = e^u$ and $v = \theta + 2k\pi, k = 0, \pm 1, \pm 2, \dots$

and $\omega = \log r + i(\theta + 2k\pi), k = 0, \pm 1, \pm 2, \dots$

But $r = |z|$ and without loss of generality, we can take $\theta \in (-\pi, \pi)$. This motivates the definition of the inverse function $f^{-1}(z)$ for $z = e^\omega$

$$\omega = \log z = \log |z| + i(\text{Arg } z + 2k\pi), k = 0, \pm 1, \pm 2, \dots$$

or, equivalently

$$\omega = \log z = \log |z| + i \arg z.$$

Mapping of the strip $|\text{Im } \omega| < \pi$ under $z = e^\omega$

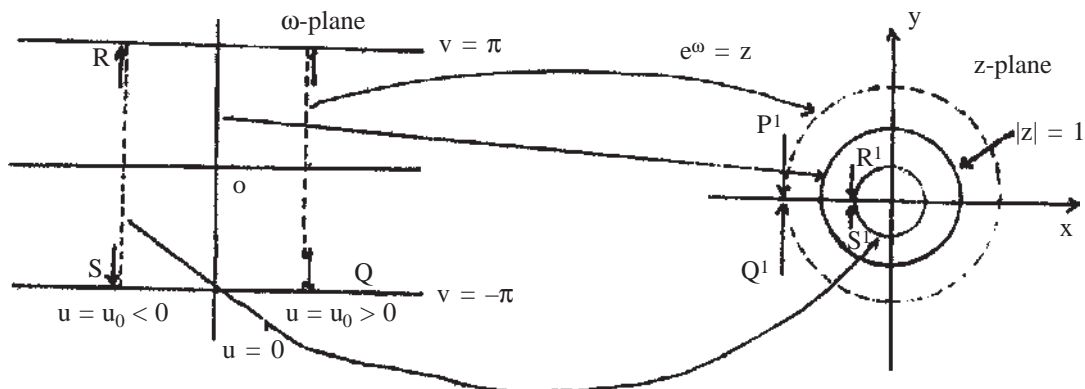

Fig. 30

I. Take $u = u_0 > 0, v \in (-\pi, \pi)$ for the line PQ :

$$x + iy = e_0^u (\cos v + i \sin v)$$

$$\Rightarrow \left. \begin{array}{l} x = e_0^u \cos v \\ y = e_0^u \sin v \end{array} \right\} \rightarrow x^2 + y^2 = e^{2u_0} > 1,$$

a full circle in z-plane outside $|z| = 1$.

Now approach Q; $u = u_0 > 0, v = -\pi + \epsilon$

$$x = e_0^u \cos(-\pi + \epsilon) \rightarrow -e_0^u \text{ as } \epsilon \rightarrow 0 + \text{ and } -e_0^u < -1 \text{ as } u_0 > 0$$

$$y = e_0^u \sin(-\pi + \epsilon) \rightarrow 0 - \text{ as } \epsilon \rightarrow 0 +$$

Now approach P : $u = u_0 > 0, v = \pi - \epsilon$

$$x = e^{u_0} \cos(\pi - \epsilon) \rightarrow -e^{u_0} \text{ as } \epsilon \rightarrow 0 +$$

$$y = e^{u_0} \sin(\pi - \epsilon) \rightarrow 0 + \text{ as } \epsilon \rightarrow 0 +$$

II. Now take $u = u_0 < 0, v \in (-\pi, \pi)$ for the line RS :

$$\Rightarrow \left. \begin{aligned} x &= e^{-u_0} \cos v \\ y &= e^{-u_0} \sin v \end{aligned} \right\} \rightarrow x^2 + y^2 = e^{-2u_0} < 1$$

represents a full circle in z-plane inside $|z| < 1$.

Approach $S : u = -u_0 < 0, v = -\pi + \epsilon$

$$x = e^{-u_0} \cos(-\pi + \epsilon) \rightarrow -e^{-u_0} > -1 \text{ as } \epsilon \rightarrow 0 +$$

$$y = e^{-u_0} \sin(-\pi + \epsilon) \rightarrow 0 - \text{ as } \epsilon \rightarrow 0 +$$

Now approach $R : u = -u_0 < 0, v = \pi - \epsilon$

$$x = e^{-u_0} \cos(\pi - \epsilon) \rightarrow -e^{-u_0} > -1 \text{ as } \epsilon \rightarrow 0 +$$

$$y = e^{-u_0} \sin(\pi - \epsilon) \rightarrow 0 \text{ as } \epsilon \rightarrow 0 +$$

Observation : Points along the negative real axis in the z-plane yield multiple w values. In order to obtain a single-valued inverse function for the fundamental strip $|\text{Im } \omega| < \pi$ we require a cut in z-plane along $\text{Re } z < 0$. The mapping $z = e^w$ and $w = f^{-1}(z)$ will be single-valued in $|\text{Im } w| < \pi$ and $z \in \mathbb{C} \setminus (-\infty, 0)$.

Clearly the inverse function $w = \text{Log } z = \log |z| + i \text{Arg } z, -\pi < \text{Arg } z \leq \pi$

is single-valued. We call this function the principal value of $\log z$.

The principal value of $\log z$ is not defined at $z = 0$ and is discontinuous as z approach the negative real axis from top and bottom. Using the necessary and sufficient conditions for differentiability we find

$$\frac{d}{dz} \text{Log } z = \frac{1}{z}, z \neq 0, z \notin (-\infty, 0)$$

The point $z = 0$ is called a branch point of $\text{Log } z$ since if we encircle the origin $z = 0$ by a closed contour then $\text{Log } z$ changes by an amount proportional to $2\pi i$.

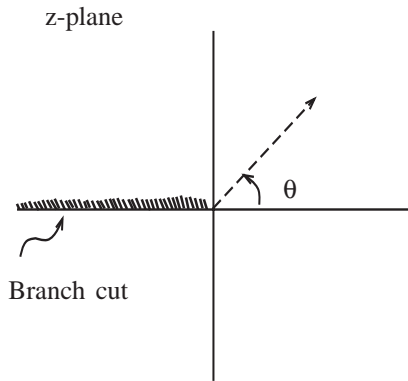

Fig. 31

4.3 Properties of $\log z$

(i) $\log (z_1 z_2) = \log z_1 + \log z_2$

(means that the set of all values of $\log z_1 + \log z_2$ is the same as the set of all values of $\log (z_1 z_2)$).

(ii) $z = e^{\log z}$, but $\log(e^z) = z + 2k\pi i$, $k = 0, \pm 1, \pm 2, \dots$

Let $z = x + iy$

$$\begin{aligned}\log e^{x+iy} &= \log(e^x) + i \left(\tan^{-1} \left(\frac{\sin y}{\cos y} \right) + 2k\pi \right) + x + iy = 2k\pi i \\ &= z + 2k\pi i, \quad k = 0, \pm 1, \dots\end{aligned}$$

(iii) $\log z^n \neq n \log z$ in general.

Let $z = re^{i\theta}$

$$\log z^n = n \log r + i(n\theta + 2k\pi), \quad k = 0, \pm 1, \dots$$

$$n \log z = n \log r + in(\theta + 2m\pi), \quad m = 0, \pm 1, \dots$$

Let n be fixed. Then the set of values of $\{k\}$, $k = 0, \pm 1, \pm 2, \dots$

do not coincide with the set of values of $\{m\}$, $m = 0, \pm 1, \pm 2, \dots$

$$\Rightarrow \log z^n \neq n \log z$$

(iv) $\log(z^{1/n}) = \frac{1}{n} \log z$ (provided the set of values are the same) $n \equiv +ve$ integer.

Now, $z = re^{i\theta}$, $z^{1/n} = r^{1/n} e^{i(\theta + 2k\pi)/n}$, $k = 0, 1, 2, \dots, n-1$

$$\log z^{1/n} = \frac{1}{n} \log r + i \left(\frac{\theta + 2k\pi}{n} + 2\ell\pi \right), \quad k = 0, 1, \dots, n-1; \ell = 0, \pm 1, \pm 2, \dots$$

$$\text{Again,} \quad \frac{1}{n} \log z = \frac{1}{n} \log r + i \left(\frac{\theta}{n} + \frac{2m\pi}{n} \right), \quad m = 0, \pm 1, \pm 2, \dots$$

The set of values of $\log(z^{1/n})$ and $1/n \log z$ are the same if the sets $\{k + n\ell\}$, $k = 0, 1, \dots, n-1; \ell = 0, \pm 1, \pm 2, \dots$ coincide with the set $\{m\}$, $m = 0, \pm 1, \pm 2, \dots$

Complex exponents

If α is complex and $z \neq 0$ then

$z^\alpha = e^{\alpha \log z}$ multi-valued.

$$z^\alpha = e^{\alpha[\log|z| + i(\text{Arg}z + 2k\pi)]}, \quad k = 0, \pm 1, \pm 2, \dots$$

$$= e^{\alpha[\log|z| + i(\theta + 2k\pi)]}$$

agrees with our previous results if $\alpha = m$, $\alpha = \frac{1}{m}$; $m = \text{integer}$. If α is a rational number

say p/q , then z^α will have only q number of distinct values, occurred against $k = 0, 1, 2, \dots, q-1$ and the values of $e^{i2pk\pi/q}$ for $k = -1, -2, \dots, -(q-1)$ coincide with

its values for $k = q - 1, q - 2, \dots, 2, 1$ respectively, whereas the values of $e^{i2pk\pi/q}$ for $k = \pm q, \pm(q + 1), \dots$ coincide with its values for $k = 0, \pm 1, \pm 2, \dots$

z^α takes infinite number of values when α is irrational or complex. Clearly there is a distinct branch of z^α for each distinct branch of $\log z$ and the branch cuts are determined as in the case of $\log z$. Every branch of z^α is analytic except at the branch point $z = 0$ and on a branch cut.

Example 2. Find all distinct values of i^{-2i} .

Solution : $i^{-2i} = e^{-2i \log i} = e^{2i \left[\log|i| + i \left(\frac{\pi}{2} + 2k\pi \right) \right]}, k = 0, \pm 1, \dots$
 $= e^{(4k + 1)\pi}, k = 0, \pm 1, \pm 2, \dots$

So, there are infinite number of values.

Example 3. Find all solutions of $z^{1-i} = 6$.

Solution : $e^{(1-i)\log z} = e^{\log 6}$

$\Rightarrow (1-i)\log z = \log 6 + 2k\pi i, k = 0, \pm 1, \pm 2, \dots$

or, $2\log z = (1+i)[\log 6 + 2k\pi i]$

or, $\log z = \frac{\log 6 - 2k\pi}{2} + \frac{i}{2}(\log 6 + 2k\pi)$

Thus, $z = e^{\log \sqrt{6} - k\pi} \left[\cos(k\pi + \log \sqrt{6}) + i \sin(k\pi + \log \sqrt{6}) \right]$
 $= \sqrt{6} e^{-k\pi} (-1)^k \left[\cos(\log \sqrt{6}) - i \sin(\log \sqrt{6}) \right]$

4.4 Branch, Branch point and Branch cut

Definition : $F(z)$ is a **Branch** of the multi-valued function $f(z)$ in a domain D if $F(z)$ is single-valued and continuous in D and has the property that for each z in D the value of $F(z)$ is one of the values of $f(z)$.

To determine $F(z)$ we introduce a line emanating from a point (called a **Branch Point**) to ensure that F is single-valued in the cut plane by the line. A **Branch Point** is one for which if we enclose it with a curve the function changes discontinuously as the variable makes a complete round over the curve.

For instance, consider $w = z^{1/2}$. Let P be a point on the z -plane where $w_1 = z_1^{1/2}$ and $\text{Arg } z_1 = \phi_1, 0 < \phi_1 < 2\pi$.

Let $z_1 = r_1 e^{i\phi_1}$, then at $P, w_1 = r_1^{1/2} e^{i\phi_1/2}$. We now encircle the region along closed

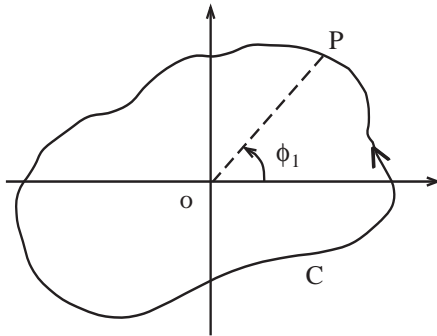

Fig. 32

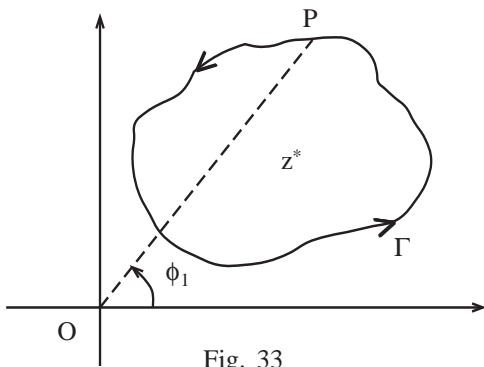

Fig. 33

curve C through P . Upon travelling anticlockwise once, we have $\phi = \phi_1 + 2\pi$, i.e., $w = r_1^{1/2} e^{i(\phi_1 + 2\pi)/2} = -r_1^{1/2} e^{i\phi_1/2}$ at the point P .

$\Rightarrow w = -w_1$ at P . This shows that w has changed discontinuously after performing a loop about $z = 0$, which establishes $z = 0$ a **Branch Point**.

Now we consider a different loop, a closed curve Γ around some point z^* which does not enclose the origin. As before, $z_1 = r_1 e^{i\theta_1}$ and $w_1 = r_1^{1/2} e^{i\phi_1/2}$ upon returning to P , travelling anticlockwise, we have $\phi = \phi_1$ again. Hence w is continuous after performing the loop. So $z = z^*$ is not a **Branch Point** for $z^{1/2} = w$.

Example 4. Discuss the multivaluedness of the function $f(z) = (z^2 - 1)^{1/2}$ and introduce cuts to obtain single-valued branches.

Solution : Let $z - 1 = r_1 e^{i\theta}$ and $z + 1 = r_2 e^{i\psi}$

Then $f(z) = \sqrt{r_1 r_2} e^{i(\theta + \psi)/2}$

We choose a branch of $f(z)$ at a point z_0 by taking values of θ_0 of θ and ψ_0 of ψ . Then at z_0 , $f(z)$ takes the value

$$f_0 = \sqrt{r_1 r_2} e^{i(\theta_0 + \psi_0)/2}$$

If now z traverses from the point z_0 , and form a simple closed contour (end point also z_0) C_0 enclosing the point $z = 1$, where the point $z = -1$ lies outside C_0 , the value of $f(z)$ at z_0 changes to

$$\sqrt{r_1 r_2} e^{i(\theta_0 + \psi_0 + 2\pi)/2} = -f_0$$

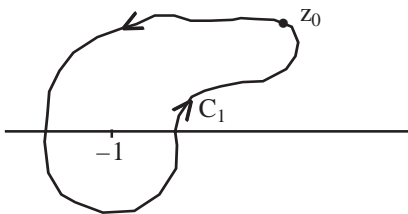

Fig. 34

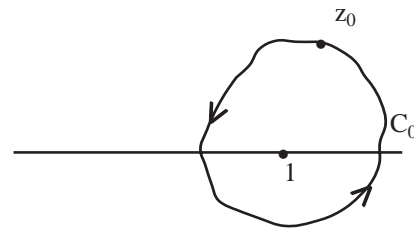

Fig. 35

$f(z)$ takes the same value $-f_0$ while z travelling from z_0 and returns to z_0 itself forming a closed contour C_1 which encloses -1 , but not 1 . Hence it is clear that -1 and 1 are the branch points for the function $f(z)$.

In order to obtain single-valued branches we introduce two different set of branch cuts. (i) A branch cut between the points -1 and 1 on the real axis. In this case consider the closed contour C enclosing the branch points -1 and 1 . Here $f(z)$ returns to the value (from its value f_0 at z_0).

$$\sqrt{r_1 r_2} e^{i(\theta_0 + 2\pi + \psi_0 + 2\pi)/2} = \sqrt{r_1 r_2} e^{i(\theta_0 + \psi_0)/2} = f_0$$

So, it is a single-valued branch.

(ii) Two branch cuts on the real-axis, $(-\infty, -1)$ and $(1, \infty)$.

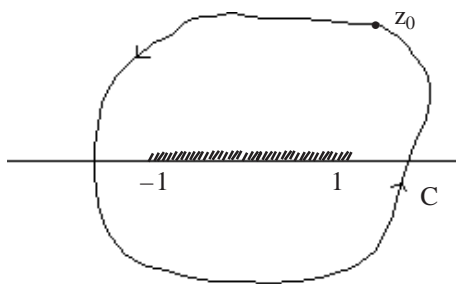

Fig. 36

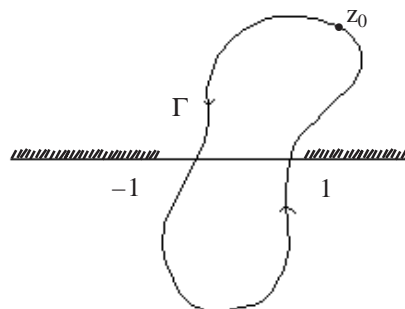

Fig. 37

Here the contour Γ does not enclose any of the branch points, so $f(z)$ remains single-valued as z makes a complete round through Γ initiating from z_0 .

Example 5. Construct a branch of $\log \left(\frac{z-1}{z+1} \right)$, which is analytic at the origin and takes the values $5\pi i$ there.

Solution : Let $g(z) = \log \left(\frac{z-1}{z+1} \right)$. The points $z = \pm 1$ are the branch points of $g(z)$ and the behaviour of $g(z)$ at these branch points are similar to $f(z)$ as shown in the previous example. We do not repeat these here.

Write both $z - 1$, and $z + 1$ in polar form :

$$z - 1 = re^{i\theta}, \quad z + 1 = \rho e^{i\psi}$$

Then we can express

$$g(z) = \log \left(\frac{re^{i\theta}}{\rho e^{i\psi}} \right) = \log \left[\frac{r}{\rho} e^{i(\theta-\psi)} \right]$$

$$= \log\left(\frac{r}{\rho}\right) + i(\theta - \psi)$$

We consider the complex z -plane with two branch cuts $(-\infty, -1)$, and $(1, \infty)$. Here the principal branch of $g(z)$ is taken as

$$\log\left(\frac{r}{\rho}\right) + i(\theta - \psi), \quad 0 \leq \theta < 2\pi; \quad -\pi \leq \psi < \pi$$

Now, $g_0 = g(0) = i\pi$

In the branch $4\pi \leq \theta < 6\pi; \pi \leq \psi < 3\pi$, $g(z)$ will take the value $5\pi i$ at the origin.

Example 6. Let $z = \omega^2$ and consider $\text{Re } \omega > 0$.

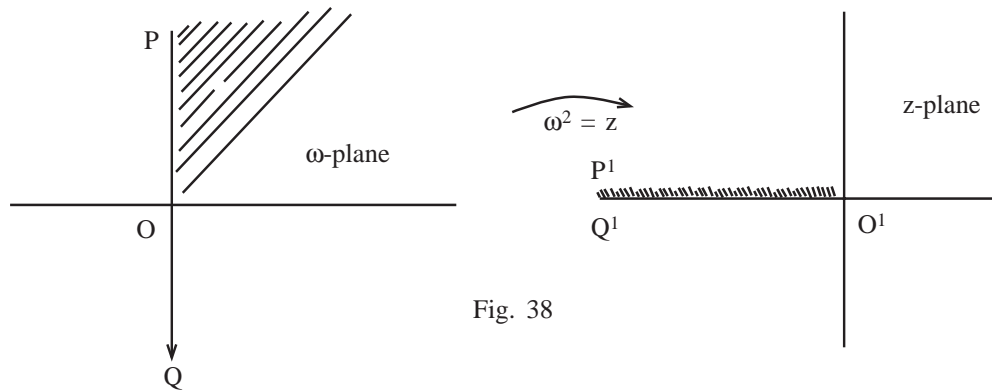

Fig. 38

Image is $z \in \mathbb{C} \setminus (-\infty, 0)$

Note : Injective mapping if $\text{Re } \omega > 0$ and $z \in \mathbb{C} \setminus (-\infty, 0)$. We need a **Branch cut** along negative real-axis in the z -plane.

Hence $w = z^{1/2}$, $z = re^{i\phi}$, $-\pi < \phi \leq \pi$

This ensures that $\text{Re } \omega > 0$. Here the points on the cut go either to P or Q. P and Q are arbitrary.

4.5 Integrals of Multi-valued functions

Example 7. Evaluate $\int_0^\infty \frac{x^{\alpha-1}}{1+x} dx$, $0 < \alpha < 1$.

Let us consider the integral

$$\int_C \frac{z^{\alpha-1}}{1-z} dz$$

where the contour C consists of a large Circle Γ_R with centre at the origin and radius R , a small circle γ_ϵ with centre origin and radius ϵ joined to the large circle

Γ_R along the negative side of the real axis from ε to R by means of a cut as shown in the figure 39. Thus we have avoided the branch point $z = 0$.

We take principal branch of $z^{\alpha-1}$. Then

$$\left| \int_{\Gamma_R} \frac{z^{\alpha-1}}{1-z} dz \right| \leq 2\pi R \frac{R^{\alpha-1}}{1+R} = \frac{2\pi R^\alpha}{1+R} \rightarrow 0 \text{ as } R \rightarrow \infty,$$

since $\alpha < 1$,

$$\left| \int_{\gamma_\varepsilon} \frac{z^{\alpha-1}}{1-z} dz \right| \leq 2\pi\varepsilon \frac{\varepsilon^{\alpha-1}}{1} = 2\pi\varepsilon^\alpha \rightarrow 0 \text{ as } \varepsilon \rightarrow 0,$$

since $\alpha > 0$.

Thus, by residue theorem,

$$\int_C \frac{z^{\alpha-1}}{1-z} dz = 2\pi i \operatorname{Res} \left[\frac{z^{\alpha-1}}{1-z}; 1 \right]$$

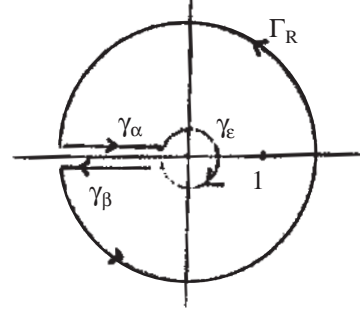

Fig. 39

Observe that $\frac{z^{\alpha-1}}{1-z}$ has a simple pole at $z = 1$ which lies inside C .

$$\text{or, } \lim_{R \rightarrow \infty} \int_{\Gamma_R} \frac{z^{\alpha-1}}{1-z} dz + \lim_{\varepsilon \rightarrow 0} \int_{\gamma_\varepsilon} \frac{z^{\alpha-1}}{1-z} dz + \int_{\gamma_\alpha} \frac{z^{\alpha-1}}{1-z} dz + \int_{\gamma_\beta} \frac{z^{\alpha-1}}{1-z} dz = -2\pi i$$

$$\text{so, } \int_{\gamma_\alpha} \frac{z^{\alpha-1}}{1-z} dz + \int_{\gamma_\beta} \frac{z^{\alpha-1}}{1-z} dz = -2\pi i \quad (54)$$

On γ_α : $z = \rho e^{i\pi}$, $0 < \rho < \infty$

so $1 - z = 1 + \rho$ and $dz = e^{i\pi} d\rho$

$$\text{and } \int_{\gamma_\alpha} \frac{z^{\alpha-1}}{1-z} dz = \int_\infty^0 e^{i\pi} \frac{\rho^{\alpha-1}}{1+\rho} e^{i\pi(\alpha-1)} d\rho = e^{i\pi(\alpha-1)} \int_0^\infty \frac{\rho^{\alpha-1}}{1+\rho} d\rho = -e^{i\pi\alpha} \int_0^\infty \frac{\rho^{\alpha-1}}{1+\rho} d\rho$$

On γ_β , $z = \rho e^{-i\pi}$, $0 < \rho < \infty$

so $1 - z = 1 + \rho$, $dz = e^{-i\pi} d\rho$, then

$$\begin{aligned} \int_{\gamma_\beta} \frac{z^{\alpha-1}}{1-z} dz + \int_0^\infty e^{-i\pi} \frac{\rho^{\alpha-1}}{1+\rho} e^{-i\pi(\alpha-1)} d\rho &= -e^{-i\pi(\alpha-1)} \int_0^\infty \frac{\rho^{\alpha-1}}{1+\rho} d\rho \\ &= e^{-i\pi\alpha} \int_0^\infty \frac{\rho^{\alpha-1}}{1+\rho} d\rho \end{aligned}$$

Substituting these integrals into (54), we get

$$[-e^{i\pi\alpha} + e^{-i\pi\alpha}] \int_0^\infty \frac{\rho^{\alpha-1}}{1+\rho} d\rho = -2\pi i$$

i.e.
$$\int_0^\infty \frac{\rho^{\alpha-1}}{1+\rho} d\rho = \frac{2\pi i}{2i \sin \pi\alpha}$$

or,
$$\int_0^\infty \frac{x^{\alpha-1}}{1+x} dx = \frac{\pi}{\sin \pi\alpha}$$

Example 8 : Evaluate $\int_0^\infty \frac{x^{\alpha-1}}{1+x^3} dx, 0 < \alpha < 3$.

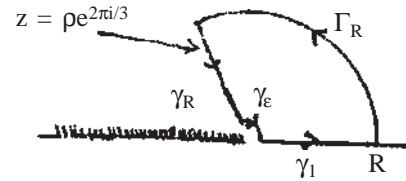

Fig. 40

We take the contour integral

$$\int_C \frac{z^{\alpha-1}}{1+z^3} dz$$
, where C is the contour as shown in the fig. 40. Take principal branch of $z^{\alpha-1}$.

Then,
$$\left| \int_{\gamma_\epsilon} \frac{z^{\alpha-1}}{1+z^3} dz \right| \geq \frac{2\pi}{3} \epsilon \frac{\epsilon^{\alpha-1}}{1} = \frac{2\pi}{3} \epsilon^\alpha \rightarrow 0 \text{ as } \epsilon \rightarrow 0 \text{ since } \epsilon > 0$$

and
$$\left| \int_{\Gamma_R} \frac{z^{\alpha-1}}{1+z^3} dz \right| \leq \frac{2\pi R}{3} \frac{R^{\alpha-1}}{R^3} = \frac{2\pi}{3} R^{\alpha-3} \rightarrow 0 \text{ as } R \rightarrow \infty \text{ since } \alpha < 3$$

Now the function $\frac{z^{\alpha-1}}{1+z^3}$ has only one simple pole $z = e^{i\pi/3}$ inside C. Thus

$$\int_C \frac{z^{\alpha-1}}{1+z^3} dz = 2\pi i \operatorname{Res} \left[\frac{z^{\alpha-1}}{1+z^3}; e^{i\pi/3} \right] = 2\pi i \cdot \frac{e^{i\pi(\alpha-1)/3}}{3e^{2\pi i/3}} = -\frac{2\pi i}{3} e^{i\alpha\pi/3}$$

i.e.,
$$\int_{\Gamma_R} \frac{z^{\alpha-1}}{1+z^3} dz + \int_{\gamma_\epsilon} \frac{z^{\alpha-1}}{1+z^3} dz + \int_R^\epsilon \frac{\rho^{\alpha-1}}{1+\rho^3} e^{2\pi i(\alpha-1)/3} e^{2\pi i/3} d\rho + \int_\epsilon^R \frac{\rho^{\alpha-1}}{1+\rho^3} d\rho = -2\pi i \frac{e^{i\alpha\pi/3}}{3}$$

[In the third integral, we used $z = \rho e^{2\pi i/3}$, $dz = e^{2\pi i/3} d\rho$, $1+z^3 = 1+\rho^3$, and in the fourth integral, $z = \rho$, $dz = d\rho$]

Taking $R \rightarrow \infty$ and $\epsilon \rightarrow 0$ in the above integrals, we find using the earlier results

$$-e^{2\pi i\alpha/3} \int_0^\alpha \frac{\rho^{\alpha-1}}{1+\rho^3} d\rho + \int_0^\alpha \frac{\rho^{\alpha-1}}{1+\rho^3} d\rho = \frac{2\pi i e^{i\alpha\pi/3}}{3}$$

So that,

$$\int_0^\infty \frac{\rho^{\alpha-1}}{1+\rho^3} d\rho = \frac{2\pi i}{3} \cdot \frac{1}{e^{\alpha\pi i/3} - e^{-\alpha\pi i/3}} = \frac{\pi}{3 \sin \frac{\alpha\pi}{3}}$$

or,

$$\int_0^\infty \frac{x^{\alpha-1}}{1+x^3} dx = \frac{\pi}{3 \sin \frac{\alpha\pi}{3}}$$

Riemann Surface

A Riemann surface is a generalization of the complex plane to a surface comprising several sheets so that a multi-valued function can have only one value corresponding to each point on that surface. Once such a surface is ascertained for a given multi-valued function, the function becomes single-valued on the surface and can be treated according to the theory of single-valued functions.

This topology removes artificial restrictions-**Branch Cuts** and gives us a more general notion of a domain so that a multi-valued analytic function becomes single-valued if it is considered as a mapping to an appropriate generalized domain as suggested by G. F. B. Riemann (1826-1866) in 1851. The idea is ingenious—a geometric construction that permits surfaces to be the domain or range of a multi-valued function.

4.6 Branch points at infinity

So far we have considered only branch points in the finite plane. Now we discuss about the possibility of a branch point at infinity. For this sake we map the point at infinity to the origin with the transformation $\zeta = 1/z$ and then examine the point $\zeta = 0$.

Example 9 : Again we consider the multi-valued function $f(z) = z^{1/2}$. Making the transformation $\zeta = \frac{1}{z}$, the point at infinity is mapped to the origin, we have $f(\zeta) = \left(\frac{1}{\zeta}\right)^{1/2}$. For each value of ζ , there are two values of $\zeta^{-1/2}$. Writing $\zeta^{-1/2}$ in modulus-argument form

$$\zeta^{-1/2} = \frac{1}{\sqrt{|\zeta|}} e^{-i\text{Arg}(\zeta)/2}$$

we find that like $z^{1/2}$, $\zeta^{-1/2}$ possesses double sheeted Riemann surface. We see that each time we walk around the origin, the argument of $\zeta^{-1/2}$ changes by $-\pi$. This means that the value of the function changes by the factor $e^{-i\pi} = -1$, i.e. the function changes sign. If we walk around the origin twice, the argument changes by -2π , so that the value of the function does not change, $e^{-2\pi i} = 1$.

Now, since $\zeta^{-1/2}$ has a branch point at zero, we conclude that $z^{1/2}$ has a branch point at infinity.

Example 10 : Again consider the multi-valued logarithm function $f(z) = \log z$. Mapping the point at infinity to the origin, we have

$$f(\zeta) = \log\left(\frac{1}{\zeta}\right) = -\log \zeta$$

But $\log \zeta$ has a branch point at $\zeta = 0$. Thus $\log z$ has a branch point at infinity.

Branch points at infinity : Paths around infinity

We can also check for a branch point at infinity by considering a path that encloses the point at infinity and no other singularities. This can be done by drawing a simple closed curve that separates the complex plane into a bounded region that contains all the singularities of the function in the finite plane. Then, depending upon the orientation, the curve is a contour enclosing all the finite singularities, or the point at infinity and no other singularities.

Once again consider the function $z^{1/2}$. We know that the function changes value on a curve that goes around the origin. Such a curve can be considered to be either a path around the origin or a path around the point at infinity. In either case the path encloses one branch point. Now consider a curve that does not go around the origin. Such a curve can be considered to be either a path around neither of the branch points or both of them. Thus we see that $z^{1/2}$ does not change value when we follow a path that encloses neither or both of its branch points.

Example 11 : Consider the multi-valued function $f(z) = (z^2 - 1)^{1/2}$. Rewriting the function $f(z) = (z - 1)^{1/2} (z + 1)^{1/2}$, we see that there are branch points at $z = \pm 1$. Now consider the point at infinity.

$$f(\zeta^{-1}) = (\zeta^{-2} - 1)^{1/2} = \pm \zeta^{-1} (1 - \zeta^2)^{1/2}$$

which shows that $f(\zeta^{-1})$ does not have a branch point at $\zeta = 0$ and $f(z)$ does not have a branch point at infinity. We might reach the same conclusion by considering a path around the point at infinity. Consider a path that encircles the branch points at $z = \pm 1$ once in the positive direction. Equivalently it encircles the point at infinity once in the negative direction. In traversing this path, the value of $f(z)$ is multiplied by the factor $(e^{2i\pi})^{1/2} (e^{2i\pi})^{1/2} = e^{2i\pi} = 1$. Thus the value of the function remains unchanged. There is no branch point at infinity.

4.7 Detection of branch points

We have the definition of a branch point, but we do not have a convenient criterion for determining if a particular function has a branch point. We have noticed that $\log z$ and z^k for non-integer k have branch points at zero and infinity. The inverse trigonometric functions like $\sin^{-1}z$, $\cos^{-1}z$ etc. also have branch points, but they can be written in terms of the logarithm and the square root. In fact all the elementary functions with branch points can be written in terms of the functions $\log z$ and z^k . Furthermore, note that the multi-valuedness of z^k comes from the logarithm, $z^k = e^{k \log z}$. This gives us a way of determining branch points of a function if there is any.

Result : Let $f(z)$ be a single-valued function. Then $\log f(z)$ and $(f(z))^k$ may have branch points only where $f(z)$ is zero or singular.

Example 12 : Consider the functions

1. $(z^2)^{1/2}$ 2. $(z^{1/2})^2$ 3. $(z^{1/2})^3$

Are they multi-valued? Do they have branch points?

Solution

1.
$$(z^2)^{1/2} = \pm\sqrt{z^2} = \pm z$$

Because of $(\cdot)^{1/2}$, the function is multi-valued. The only possible branch points are at zero and point at infinity. If $(e^{i\theta})^{1/2} = 1$, then as $((e^{2\pi i})^2)^{1/2} = (e^{4\pi i})^{1/2} = e^{2\pi i} = 1$ the function does not change value when we walk around the origin. We can also consider this to be a path around infinity. This function is multi-valued, but has no branch points.

2.
$$(z^{1/2})^2 = (\pm\sqrt{z})^2 = z$$

This function is single-valued.

3.
$$(z^{1/2})^3 = (\pm\sqrt{z})^3 = \pm(\sqrt{z})^3$$

This function is multi-valued. We consider the possible branch point at $z = 0$. If $(e^{i0})^{1/2})^3 = 1$, then as $((e^{2i\pi})^{1/2})^3 = ((e^{i\pi})^{1/2})^3 = (e^{i\pi})^3 = e^{3\pi i} = -1$, the function changes value when we walk around the origin. So it has a branch point at $z = 0$. Since this is also a path around infinity, there is a branch point at the point at infinity.

Example 13 : Consider the function $f(z) = \log(1/z - 1)$. Since $\frac{1}{z-1}$ has only zero at infinity and its only singularity (a pole here) is at $z = 1$, the only, possible branch points are at $z = 1$ and $z = \infty$.

Here $f(z) = \log\left(\frac{1}{z-1}\right) = -\log(z-1) = \log \omega$, say

We know that $\log \omega$ has branch points at zero and infinity, so $f(z)$ has branch points at $z = 1$ and $z = \infty$.

Example 14 : Consider the functions

1. $e^{\log z}$
2. $\log e^z$

Are they multi-valued? Do they have branch points?

Solution :

$$1. \quad e^{\log z} = e^{\log z + i2\pi k}, \quad k = 0, \pm 1, \dots$$

$$= e^{\text{Log} z} e^{i2\pi k} = z$$

The function is single-valued.

$$2. \quad \log e^z = \text{Log} e^z + i2\pi k = z + i2\pi k, \quad k = 0, \pm 1, \dots$$

This function is multi-valued. It may have branch points only where e^z is zero or infinite. This occurs only at $z = \infty$. Thus there are no branch points in the finite plane. The function does not change when traversing a simple closed path and since this path can be considered to enclose the point at infinity, there is no branch point at infinity.

Note : Let $f(z)$ be single-valued and have either a zero or a singularity at $z = z_0$. Then $\{f(z)\}^k$ may have a branch point at $z = z_0$. If $f(z)$ is not a power of z , then we are not sure whether $\{f(z)\}^k$ changes value when we walk around z_0 .

Now if $f(z)$ can be decomposed into factors $f(z) = h(z) g(z)$, where $h(z)$ is finite and non zero at z_0 , then from $g(z)$ we know how fast $f(z)$ vanishes or tends to infinity. Again $\{f(z)\}^k = \{h(z)\}^k \{g(z)\}^k$ and $\{h(z)\}^k$ does not have a branch point at z_0 . So that $\{f(z)\}^k$ has a branch point at z_0 if and only if $\{g(z)\}^k$ has a branch point there.

Similarly, we can decompose

$$\log \{f(z)\} = \log \{h(z)g(z)\} = \log \{h(z)\} + \log \{g(z)\}$$

to see that $\log \{f(z)\}$ has a branch point at z_0 if and only if $\log \{g(z)\}$ has a branch point there.

Example 15 : Consider the functions :

1. $\sin z^{1/2}$
2. $(\sin z)^{1/2}$
3. $z^{1/2} \cos z^{1/2}$
4. $(\sin z^2)^{1/2}$.

Find the branch points and the number of branches.

Solution : 1. $\sin z^{1/2} = \sin(\pm\sqrt{z}) = \pm \sin \sqrt{z}$

So it is multi-valued. It has two branches and the possible branch points are zero and infinity. Consider the unit circle $|z| = 1$ which is a path around the origin and infinity. If

$$\sin(e^{i0})^{1/2} = \sin(1), \text{ then as}$$

$$\sin((e^{i2\pi})^{1/2}) = \sin(e^{i\pi}) = \sin(-1) = -\sin 1,$$

there are branch points at the origin and infinity

$$2. \quad (\sin z)^{1/2} = \pm\sqrt{\sin z}$$

The function is multi-valued and has two branches. The sine function vanishes at $z = n\pi$ and is singular at infinity. These may be branch points of the function. Consider the point $z = n\pi$. We can express

$$\sin z = (z - n\pi) \frac{\sin z}{z - n\pi}, \quad n \text{ an integer.}$$

$$\text{But} \quad \lim_{z \rightarrow n\pi} \frac{\sin z}{z - n\pi} = \lim_{z \rightarrow n\pi} \frac{\cos z}{1} = (-1)^n$$

So, $(\sin z)^{1/2}$ has branch points at $z = n\pi$ since $(z - n\pi)^{1/2}$ has a branch point at $z = n\pi$.

Here the branch points are $z = n\pi$, $n = 0, \pm 1, \dots$ and they go to infinity. So it is not possible to make a path that encloses infinity and no other singularities. The point at infinity is a non-isolated singularity. A point can be a branch point only if it is an isolated singularity.

$$3. \quad z^{1/2} \cdot \cos z^{1/2} = \pm\sqrt{z} \cos(\pm\sqrt{z}) \\ = \pm\sqrt{z} \cos \sqrt{z}$$

The function is multi-valued. It may possess branch points at $z = 0$ and $z = \infty$. If $(e^{i0})^{1/2} \cos(e^{i0})^{1/2} = \cos(1)$, then as $(e^{i2\pi})^{1/2} \cos((e^{i2\pi})^{1/2}) = (-1)\cos(e^{i\pi}) = -\cos(-1) = -\cos 1$, there are branch points at the origin and infinity.

$$4. \quad (\sin z^2)^{1/2} = \pm\sqrt{\sin z^2}$$

The function is multi-valued. Now since $\sin z^2 = 0$ at $z = (n\pi)^{1/2}$, there may be branch points there.

We consider first the point $z = 0$. We can write

$$\sin z^2 = z^2 \frac{\sin z^2}{z^2}$$

$$\text{but} \quad \lim_{z \rightarrow 0} \frac{\sin z^2}{z^2} = \lim_{z \rightarrow 0} \frac{2z \cos z^2}{2z} = 1$$

So, $(\sin z^2)^{1/2}$ does not have a branch point at $z = 0$ as $(z^2)^{1/2}$ does not have a branch point there.

Next consider the point $z = \sqrt{n\pi}$

$$\sin z^2 = (z - \sqrt{n\pi}) \frac{\sin z^2}{z - \sqrt{n\pi}}$$

but
$$\lim_{z \rightarrow \sqrt{n\pi}} \frac{\sin z^2}{z - \sqrt{n\pi}} = \lim_{z \rightarrow \sqrt{n\pi}} \frac{2z \cos z^2}{1} = 2\sqrt{n\pi}(-1)^n$$

Since $(z - \sqrt{n\pi})^{1/2}$ has a branch point at $z = \sqrt{n\pi}$, $(\sin z^2)^{1/2}$, too as a branch point there.

Thus we see that $(\sin z^2)^{1/2}$ has branch points at $z = (n\pi)^{1/2}$ for $n \in \mathbb{Z} \setminus \{0\}$. This is the set of numbers : $\{\pm\sqrt{\pi}, \pm\sqrt{2\pi}, \dots, \pm i\sqrt{\pi}, \pm i\sqrt{2\pi}, \dots\}$. The point at infinity is a non-isolated singularity and hence it is not included in the set of branch points.

Example 16 : Find the branch points of

$$f(z) = (z^3 - z)^{1/3}$$

and introduce the branch cuts. If $f(3) = 2\sqrt[3]{3}$, find $f(-3)$.

Solution : Here $f(z) = z^{1/3}(z - 1)^{1/3} (z + 1)^{1/3}$

So the branch points are at $z = -1, 0$ and 1 . We consider the point at infinity

$$\begin{aligned} f\left(\frac{1}{\zeta}\right) &= \left(\frac{1}{\zeta}\right)^{1/3} \left(\frac{1}{\zeta} - 1\right)^{1/3} \left(\frac{1}{\zeta} + 1\right)^{1/3} \\ &= \frac{1}{\zeta} (1 - \zeta)^{1/3} (1 + \zeta)^{1/3} \end{aligned}$$

Since $f(1/\zeta)$ does not have a branch point at $\zeta = 0$, $f(z)$ does not have a branch point at infinity.

Here we give three possible branch cuts :

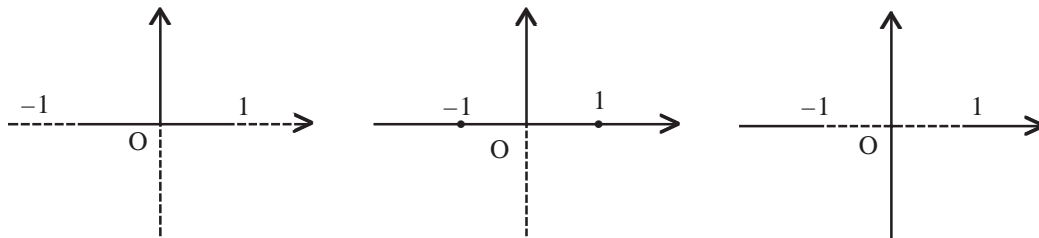

Fig. 41 Three possible branch cuts for $f(z) = (z^3 - z)^{1/3}$

In the first and third the function is single-valued but in the second it is not. It is clear that the first branch cut does not allow us to walk around any of the branch points.

The second branch cut allows us to walk around the branch points at $z = \pm 1$. If we walk around these two once in the positive direction, the value of the function would change by the factor $e^{i4\pi/3}$.

The third branch cut allows us to walk around all the three branch points, the value of the function will not change (since $e^{i6\pi/3} = e^{i2\pi} = 1$).

To find $f(-3)$, we consider the third branch cut with $f(3) = 2\sqrt[3]{3}$.

$$f(3) = (3e^{i0})^{1/3} (2e^{i0})^{1/3} (4e^{i0})^{1/3} = 2\sqrt[3]{3}$$

The value of $f(-3)$ is

$$f(-3) = (3e^{i\pi})^{1/3} (2e^{i\pi})^{1/3} (4e^{i\pi})^{1/3} = -2\sqrt[3]{3}$$

Example 17 : Determine the branch points of the function $f(z) = (z^3 - 1)^{1/2}$.

Construct branch cuts and define a branch so that $z = 0$ and $z = -1$ do not lie on a cut, such that $f(0) = -i$; then what is $f(-1/2)$?

Solution : The roots of the equation $z^3 - 1 = 0$ are

$$\left\{1, e^{i2\pi/3}, e^{i4\pi/3}\right\} = \left\{1, \frac{-1 + i\sqrt{3}}{2}, \frac{-1 - i\sqrt{3}}{2}\right\}$$

so that,

$$(z^3 - 1)^{1/2} = (z - 1)^{1/2} \left(z + \frac{1 - i\sqrt{3}}{2}\right)^{1/2} \left(z + \frac{1 + i\sqrt{3}}{2}\right)^{1/2}$$

There are branch points at each of the cube roots of unity

$$z = \left\{1, \frac{-1 + i\sqrt{3}}{2}, \frac{-1 - i\sqrt{3}}{2}\right\}$$

Now we examine the point at infinity. We make the change of variable $z = 1/\zeta$

$$f(1/\zeta) = (1/\zeta^3 - 1)^{1/2} = \zeta^{-3/2}(1 - \zeta^3)^{1/2}$$

$\zeta^{-3/2}$ has a branch point at $\zeta = 0$, while $(1 - \zeta^3)^{1/2}$ is not singular there. Since $f(1/\zeta)$ has a branch point at $\zeta = 0$, $f(z)$ has a branch point at infinity.

There are several ways of introducing branch cuts to separate the branches of the function. The easiest approach is to put a branch cut from each of the three branch points in the finite complex plane out to the branch point at infinity (see Figure 42a). Clearly this makes the function single-valued as it is impossible to walk around any of the branch points. Another approach is to have a branch cut from one of the branch points in the finite plane to the branch point at infinity and a branch cut connecting the remaining two branch points (see Figure 42 bcd). In this case, in walking around

any one of the finite branch points (in the +ve direction), the argument of the function changes by π . This means that the value of the function changes by $e^{i\pi}$, which is to say, the value of the function changes sign. In walking around any two of the finite branch points (in the +ve direction), the argument of the function changes by 2π i.e., the value of the function changes by $e^{i2\pi}$, that means the value of the function does not change.

Figure 42. Branch cuts for $(z^3-1)^{1/2}$

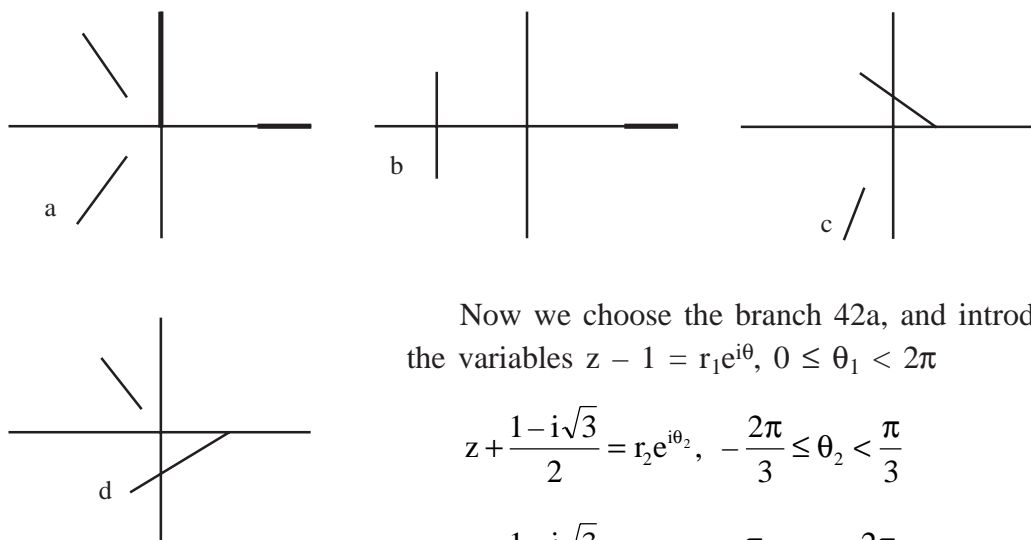

Now we choose the branch 42a, and introduce the variables $z - 1 = r_1 e^{i\theta_1}$, $0 \leq \theta_1 < 2\pi$

$$z + \frac{1 - i\sqrt{3}}{2} = r_2 e^{i\theta_2}, \quad -\frac{2\pi}{3} \leq \theta_2 < \frac{\pi}{3}$$

$$z + \frac{1 + i\sqrt{3}}{2} = r_3 e^{i\theta_3}, \quad -\frac{\pi}{3} \leq \theta_3 < \frac{2\pi}{3}$$

We compute $f(0)$ to see whether it has the desired value,

$$f(z) = \sqrt{r_1 r_2 r_3} e^{i(\theta_1 + \theta_2 + \theta_3)/2}$$

$$f(0) = e^{i(\pi - \pi/3 + \pi/3)/2} = e^{i\pi/2} = i$$

Since it does not have the desired value, we change the range of θ_1 ,

$$z - 1 = r_1 e^{i\theta_1}, \quad 2\pi \leq \theta_1 < 4\pi$$

$f(0)$ now has the desired value,

$$f(0) = e^{i(3\pi - \pi/3 + \pi/3)} = -i$$

We compute $f\left(-\frac{1}{2}\right)$,

$$f\left(-\frac{1}{2}\right) = \sqrt{\frac{3}{2} \cdot \frac{\sqrt{3}}{2} \cdot \frac{\sqrt{3}}{2}} e^{i\left(3\pi - \frac{\pi}{2} + \frac{\pi}{2}\right)/2}$$

$$= \sqrt{\frac{9}{8}} e^{i3\pi/2} = \frac{-3i}{2\sqrt{2}}$$

Example 18 : Identify the branch points of the function

$$\omega = f(z) = (z^3 + z^2 - 6z)^{1/2}$$

in the extended complex plane. Specify the branch cuts and select a branch that gives a single-valued function where it is continuous at $z = -1$ with $f(-1) = -\sqrt{6}$.

Solution : First we factor the function

$$f(z) = [z(z - 2)(z + 3)]^{1/2} = z^{1/2}(z - 2)^{1/2}(z + 3)^{1/2}$$

There are branch points at $z = -3, 0, 2$. Now we examine the point at infinity.

$$f(1/\zeta) = \left[\frac{1}{\zeta} \left(\frac{1}{\zeta} - 2 \right) \left(\frac{1}{\zeta} + 3 \right) \right]^{1/2} = \zeta^{-3/2} [(1 - 2\zeta)(1 + 3\zeta)]^{1/2}$$

Since $\zeta^{-3/2}$ has a branch point at $\zeta = 0$ and the rest of the terms are analytic there, $f(z)$ has a branch point at infinity.

Now consider the branch cuts given in the figure 43. These cuts do not permit us to walk around any single branch point. We can walk around none of the branch points (or all of the branch points considering the cuts $[-3, 2]$ and $x = 0, y \leq 0$). The cuts can be used to define a single-valued branch of the function.

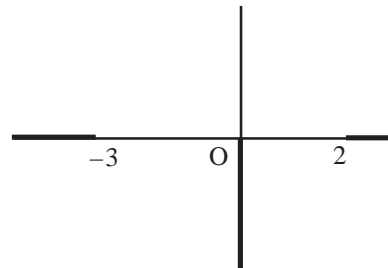

Fig. 43

Now to define the branch, we choose $z + 3 = r_1 e^{i\theta_1}$, $-\pi \leq \theta_1 < \pi$; $z = r_2 e^{i\theta_2}$, $-\frac{\pi}{2} \leq \theta_2 < \frac{3\pi}{2}$ and $z - 2 = r_3 e^{i\theta_3}$, $0 \leq \theta_3 < 2\pi$.

The function is, $f(z) = (r_1 r_2 r_3)^{1/2} e^{i(\theta_1 + \theta_2 + \theta_3)/2}$

Here $f(-1) = [(2)(1)(3)]^{1/2} e^{i(0 + \pi + \pi)/2} = -\sqrt{6}$

So our choice of angles gave the desired branch.

4.8 The Riemann surface for $\omega = z^{1/2}$

We have seen that $\omega = z^{1/2}$ possesses two branch points $z = 0$ and $z = \infty$. To utilize the developments made in Example 1, we introduce a branch cut along the negative real axis. The given function has two values for any $z \neq 0$.

$$f_1(z) = r^{1/2} e^{i\theta/2}, \quad -\pi < \theta \leq \pi$$

and $f_2(z) = r^{1/2} e^{i\theta/2}, \pi < \theta \leq 3\pi$

Each function f_1 and f_2 is single-valued on the domain formed by cutting the z -plane along the negative real-axis. Let D_1 and D_2 be the domains of f_1 and f_2

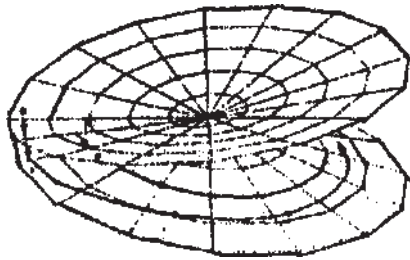

Fig. 44

respectively. The range set for f_1 is the set R_1 consisting of the right-half plane and the positive imaginary axis [see Figure 28b]; the range set for f_2 is the set R_2 consisting of the left-half plane and the negative imaginary axis [see Figure 29b]. The sets R_1 and R_2 are glued together along the positive imaginary axis and the negative imaginary axis to form the w -plane with the origin deleted. We stack D_1

directly above D_2 . The edge of D_1 in the upper-half plane is joined to the edge of D_2 in the lower-half plane, and the edge of D_1 in the lower-half plane is joined to the edge of D_2 in the upper-half plane (it is needless to mention that the line of joining is the negative real-axis). When these domains are glued together in this manner, they form a Riemann surface domain for the mapping $w = f(z) = z^{1/2}$ shown in the figure 44 for some finite r .

4.9 Concept of neighbourhood

When a point lies on the boundary of two domains D_1 and D_2 , we define a neighbourhood of that point in the following manner. Here the boundary of D_1 and D_2 is the negative real-axis. (i) Neighbourhood of a point $\zeta \in D_1$ with $\text{Im } \zeta < 0, \text{Arg } \zeta = \pi, |z - \zeta| < \epsilon$ consists of points on : (a) D_1 if $\text{Im } \zeta \geq 0$ (b) D_2 if $\text{Im } \zeta < 0$. (ii) Neighbourhood of a point $\eta \in D_2$ with $\text{Im } \eta = 0, \text{Arg } \eta = 3\pi, |z - \eta| < \epsilon$ consists of points on (a) D_1 if $\text{Im } \eta < 0$ and (b) D_2 if $\text{Im } \eta \geq 0$. With these definitions of neighbourhood of a point, it becomes clear that $w = z^{1/2}$ is continuous and differentiable everywhere on the Riemann surface except at the origin and the point at infinity. The derivative is given by

$$\frac{d}{dz} z^{1/2} = \begin{cases} \frac{1}{2} \frac{1}{f_1} & \text{on } D_1 \\ \frac{1}{2} \frac{1}{f_2} & \text{on } D_2 \end{cases}$$

4.10 The Riemann Surface for $w = \log z$

The Riemann surface for the multivalued function $\omega = \log z$ is similar to the one we presented for the square root function. However, it requires infinitely many copies of the z -plane cut along the negative x -axis, which mark S_k for $k = \dots, -n, \dots, -1, 0, 1, \dots, n, \dots$. Now we stack these cut planes directly on each other so that the corresponding points have the same position. We join the sheet S_k to S_{k+1} as follows. For each integer k , the edge of the sheet S_k in the upper half-plane is joined to the edge of the sheet S_{k+1} in the lower-half plane. The Riemann surface for the domain of $\log z$ looks like a spiral staircase that extends upward on the sheets S_1, S_2, \dots , and downward on the sheets S_{-1}, S_{-2}, \dots as shown in figure 45. For S_k , we use

$$z = re^{i\theta} = r (\cos \theta + i \sin \theta), \text{ where}$$

$$r = |z| \text{ and } 2\pi k - \pi < \theta \leq \pi + 2\pi k$$

Again, for S_k , the correct branch of $\log z$ on each sheet is

$$\log z = \log r + i \theta, \text{ where}$$

$$r = |z| \text{ and } 2\pi k - \pi < \theta \leq \pi + 2\pi k$$

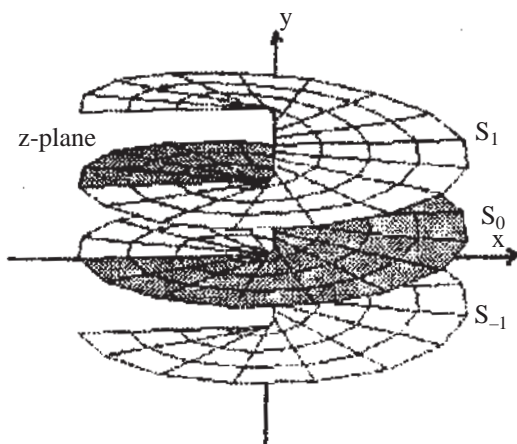

Fig. 45

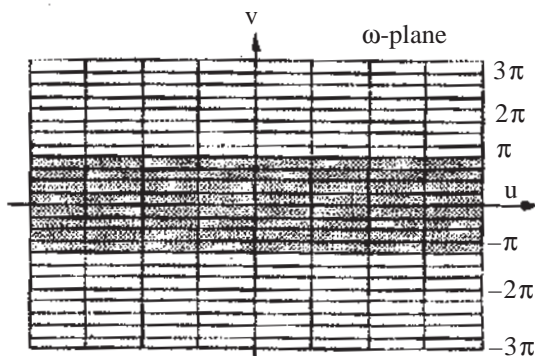

Fig. 46

Example 19 : Form a Riemann surface for $f(z) = (z - 1)^{1/3}$ taking a branch cut along the line $y = 0, x \geq 1$. Detect the point where the function takes the value $\sqrt{2} (i - 1)$.

Solution : Let $r = |z - 1|$ and $\theta = \arg (z - 1)$, where $0 \leq \theta < 2\pi$. Here the Riemann surface consists of three domains D_1, D_2 and D_3 :

$$f_1(z) = r^{1/3} e^{i\theta/3}, \quad 0 \leq \theta < 2\pi \quad (D_1)$$

$$f_2(z) = r^{1/3} e^{i\theta/3}, \quad 2\pi \leq \theta < 4\pi \quad (D_2)$$

$$f_3(z) = r^{1/3} e^{i\theta/3}, \quad 4\pi \leq \theta < 6\pi \quad (D_3)$$

Each function f_1 , f_2 and f_3 is single-valued on the domain formed by cutting the z -plane along the line $y = 0, x \geq 1$.

We place D_1 on the top, then D_2 and D_3 . The edge of D_1 in the upper-half plane is joined to the edge of D_2 in the lower-half plane and the edge of D_2 in the upper-half plane is joined to the edge of D_3 in the lower-half plane and finally the edge of D_3 in the upper-half plane is joined to the edge of D_1 in the lower-half plane.

Say at $z = \zeta$, $f(\zeta) = \sqrt{2} (i - 1)$

$$\begin{aligned} \text{i.e.} \quad f(\zeta) &= -2 \left(\frac{1}{\sqrt{2}} - \frac{i}{\sqrt{2}} \right) \\ &= 2e^{i\pi} e^{-\frac{i\pi}{4}} = 2e^{i3\pi/4} \\ &= 2e^{i\left(\frac{9\pi}{4}\right)/3} = 2e^{i\left(\frac{\pi}{4} + 2\pi\right)/3} \end{aligned}$$

So, $\zeta - 1 = 2^3 e^{\frac{i\pi}{4}}, \zeta = 1 + 8e^{\frac{i\pi}{4}}$ lying in the domain D_2 .

Example 20 : Form the Riemann surface for the function $f(z) = (z^2 - 1)^{1/2}$.

Solution : Here the given function $f(z) = (z^2 - 1)^{1/2}$ has branch points at $z = \pm 1$. To examine the point at infinity, we substitute $z = 1/\zeta$ and examine the point $\zeta = 0$.

$$f\left(\frac{1}{\zeta}\right) = \left[\left(\frac{1}{\zeta}\right)^2 - 1 \right]^{1/2} = \frac{1}{(\zeta^2)^{1/2}} (1 - \zeta^2)^{1/2}$$

Since there is no branch point at $\zeta = 0$, $f(z)$ has no branch point at infinity.

Let $z - 1 = r_1 e^{i\phi_1}$ and $z + 1 = r_2 e^{i\phi_2}$,

where $\phi_1 = \text{Arg}(z - 1)$ and $\phi_2 = \text{Arg}(z + 1)$. Then $\omega = f(z) = (z^2 - 1)^{1/2} = (z - 1)^{1/2} (z + 1)^{1/2} = (r_1 r_2)^{1/2} e^{i(\phi_1 + \phi_2)}$

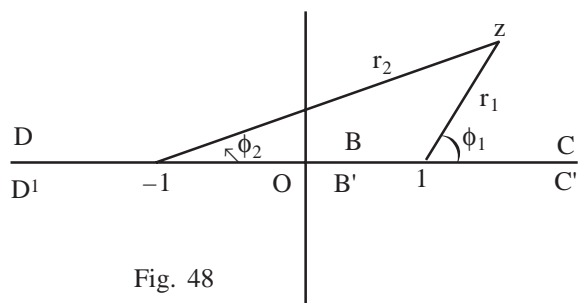

Fig. 48

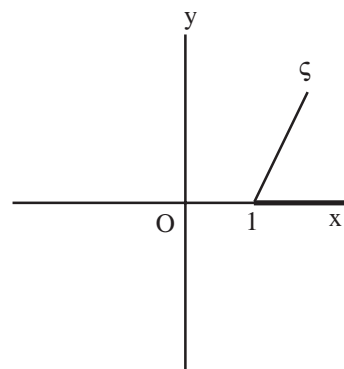

Fig. 47

Case-I $0 \leq \phi_1 < 2\pi, 0 \leq \phi_2 < 2\pi$

on the segment	ϕ_1	ϕ_2	$e^{i(\phi_1+\phi_2)/2}$	Continuity of $f(z)$
B	π	0	i	No
B'	π	2π	-i	
C	0	0	1	Yes
C'	2π	2π	1	
D	π	π	-1	Yes
D'	π	π	-1	

Fig. 49

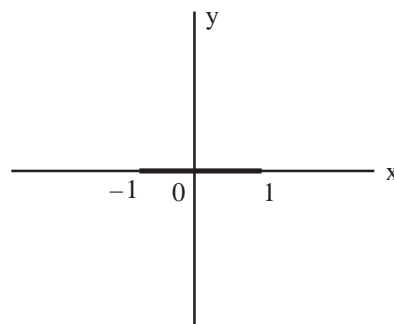

Fig. 50 Branch cut $[-1, 1]$

Case-II $0 \leq \phi_1 < 2\pi, -\pi \leq \phi_2 < \pi$

on the segment	ϕ_1	ϕ_2	$e^{i(\phi_1+\phi_2)/2}$	Continuity of $f(z)$
B	π	0	i	Yes
B'	π	0	i	
C	0	0	1	No
C'	2π	0	-1	
D	π	π	-1	No
D'	π	$-\pi$	1	

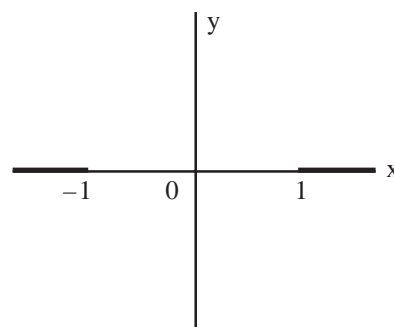

Fig. 51 Branch cuts $(-\infty, -1]$ and $[1, \infty)$

Two branches of $(z - 1)^{1/2}$ can be taken as

$$f_1(z) = \sqrt{r_1} e^{i\phi_1/2} \quad \text{and} \quad f_2(z) = \sqrt{r_1} e^{i(\phi_1+2\pi)/2}, \quad 0 \leq \phi_1 < 2\pi = -f_1(z)$$

Again two branches of $(z + 1)^{1/2}$ can be taken as

$$g_1(z) = \sqrt{r_2} e^{i\phi_2/2} \quad \text{and} \quad g_2(z) = \sqrt{r_2} e^{i(\phi_2+2\pi)/2}, \quad 0 \leq \phi_2 < 2\pi \\ = -g_1(z)$$

Let us construct a Riemann surface for $\omega = (z^2 - 1)^{1/2}$ considering case I.

Here a Riemann surface consists of two sheets S_0 and S_1 . Let S_0 be an extended complex plane cut along the real axis from $z = -1$ to $z = 1$ and S_1 be another extended complex plane cut of similar nature.

$$S_0 \begin{cases} 0 \leq \text{Arg}(z-1) < 2\pi \\ 0 \leq \text{Arg}(z+1) < 2\pi \end{cases} \quad S_1 \begin{cases} 2\pi \leq \text{Arg}(z-1) < 4\pi \\ 2\pi \leq \text{Arg}(z+1) < 4\pi \end{cases}$$

The sheets S_0 and S_1 are joined along the segment $[-1, 1]$ in such a way that the lower edge of the slit in S_0 is joined to the upper edge of the slit in S_1 , and the lower edge of the slit in S_1 is joined to the upper edge of the slit in S_0 .

Let a point on the sheet S_0 move anticlockwise and form a simple closed curve which encloses the segment $[-1, 1]$ once. Then both ϕ_1 and ϕ_2 change by an amount 2π upon returning to their original position. i.e. $(\phi_1 + \phi_2)/2$ changes by an amount 2π , so the value of

$$\omega = (r_1 r_2)^{1/2} e^{i(\phi_1 + 2\pi + \phi_2 + 2\pi)/2} = (r_1 r_2)^{1/2} e^{i(\phi_1 + \phi_2)/2}$$

remains unchanged.

Then $\omega = f_1 g_1$ on S_0 and as well as on S_1 .

If a point starting on the sheet S_0 travels a path which makes a complete round about only the branch point $z = 1$, it crosses from the sheet S_0 to S_1 . In this case, the value of ϕ_1 changes by an amount 2π , while the value of ϕ_2 does not change at all. The change in $(\phi_1 + \phi_2)/2$ is then π . The change in $(\phi_1 + \phi_2)/2$ remains the same if a point on the sheet S_0 makes a complete round about the branch point $z = -1$ only and enters on the S_1 sheet. This time.

$$\omega = \begin{cases} f_1 g_1 & \text{on } S_0 \\ -f_1 g_1 & \text{on } S_1 \end{cases}$$

Thus the double-valued function $\omega = (z^2 - 1)^{1/2}$ can now be considered as a single-valued function on the Riemann surface constructed above. Hence the transformation $\omega = (z^2 - 1)^{1/2}$ maps each of the sheets S_0 and S_1 forming the Riemann surface on the entire ω -plane.

Riemann surface for the case II

Here the Riemann surface is formed by two sheets S_0 and S_1 . Each of these sheets is an extended complex plane cut along the line $(-\infty, -1) \cup [1, \infty)$

$$S_0 \begin{cases} 0 \leq \text{Arg}(z-1) < 2\pi \\ -\pi \leq \text{Arg}(z+1) < \pi \end{cases} \quad S_1 \begin{cases} 2\pi \leq \text{Arg}(z-1) < 4\pi \\ \pi \leq \text{Arg}(z+1) < 3\pi \end{cases}$$

These sheets are joined along the line $(-\infty, -1] \cup [1, \infty)$ in such a way that the lower edge of the slit in S_0 is joined to the upper edge of the slit in S_1 , and the lower edge of the slit in S_1 is joined to the upper edge of the slit in S_0 .

If a point traverses a simple closed curve on either of the sheets S_0 or S_1 not enclosing any of the branch points -1 or 1 , then the function $f(z)$ remains single-valued on the respective sheet, whereas if it encloses any one of the branch points the function changes the branch as explained in case I. In the same way the double-valued function $f(z) = (z^2 - 1)^{1/2}$ can be treated as a single-valued function on the Riemann surface formed earlier.

Example 21 : The power function $\omega = f(z) = [z(z-1)(z-2)]^{1/2}$ has two branches. Show that $f(-1)$ can be either $-\sqrt{6}i$ or $\sqrt{6}i$. Suppose the branch that corresponds to $f(-1) = -\sqrt{6}i$ is chosen, find the value of the function at $z = i$.

Solution : The given power function can be expressed as

$$\omega = f(z) = \sqrt{|z(z-1)(z-2)|} e^{i[\text{Arg}z + \text{Arg}(z-1) + \text{Arg}(z-2)]/2} e^{ik\pi}, \quad k = 0, 1$$

where the two possible values of k correspond to the two branches of the double-valued power function.

If figure 52a branch cuts are $y = 0, x \leq 0$ and $y = 0, 1 \leq x \leq 2$ and in figure 52b branch cuts are $y = 0, 0 \leq x \leq 1$ and $y = 0, x \geq 2$. In both the cases Riemann surface is formed by two branches.

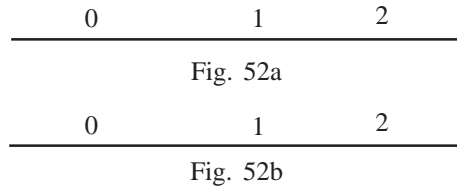

At $z = -1$, we note that

$$\text{Arg } z = \text{Arg } (z - 1) = \text{Arg } (z - 2) = \pi \text{ and } \sqrt{|z(z-1)(z-2)|} = \sqrt{6}.$$

So, $f(-1)$ can be either $\sqrt{6}e^{i3\pi/2} = -\sqrt{6}i$ or $\sqrt{6}e^{i(\pi+2\pi+\pi+2\pi+\pi+2\pi)/2} = \sqrt{6}e^{i3\pi/2}e^{i\pi} = \sqrt{6}i$.

The branch that gives $f(-1) = \sqrt{6}i$ corresponds to $k = 0$. With the choice of that branch, we find

$$\begin{aligned} f(i) &= \sqrt{|i(i-1)(i-2)|} e^{i[\text{Arg}i + \text{Arg}(i-1) + \text{Arg}(i-2)]/2} \\ &= \sqrt{\sqrt{2}\sqrt{5}} e^{i(\pi/2 + 3\pi/4 + \pi - \tan^{-1}1/2)/2} = \sqrt[4]{10} e^{i\left(\frac{\pi}{4} - \tan^{-1}\frac{1}{2}\right)/2} e^{i\pi} \\ &= -\sqrt[4]{10} e^{i(\tan^{-1}1 - \tan^{-1}1/2)/2} = -\sqrt[4]{10} e^{i(\tan^{-1}1/3)/2} \end{aligned}$$

4.11 The Inverse Trigonometric Functions

(i) The function $\sin^{-1}z$ is defined by the equation

$$z = \sin \omega$$

Substituting $\frac{e^{i\omega} - e^{-i\omega}}{2i}$ for $\sin \omega$, we find that

$$(e^{i\omega})^2 - 2ie^{i\omega}z - 1 = 0$$

i.e., $e^{i\omega} = iz + (1 - z^2)^{1/2}$

$\Rightarrow i\omega = \log\{iz + (1 - z^2)^{1/2}\}$

so that $\sin^{-1}z = -i \log\{iz + (1 - z^2)^{1/2}\}$

Similarly, we can have

$$\cos^{-1}z = -i \log\{z + (z^2 - 1)^{1/2}\}$$

(ii) We take the function $\omega = \tan^{-1}z$, which is the inverse of $z = \tan \omega$. Expressing $\tan \omega$ in terms of $\sin \omega$ and $\cos \omega$ and then converting to their exponential form, we get

$$z = \frac{1 e^{i\omega} - e^{-i\omega}}{i e^{i\omega} + e^{-i\omega}}$$

$$= \frac{1 e^{2i\omega} - 1}{i e^{2i\omega} + 1}$$

i.e.,
$$iz = \frac{e^{2i\omega} - 1}{e^{2i\omega} + 1} \Rightarrow e^{2i\omega} = \frac{1 + iz}{1 - iz}$$

and finally,
$$\omega = \frac{1}{2i} \log \frac{1 + iz}{1 - iz}$$

Note : When $z \neq \pm 1$, the quantity $(1 - z^2)^{1/2}$ has two possible values. For each value, the logarithm generates infinitely many values. Therefore $\sin^{-1}z$ has two sets of infinite values. For example, consider

$$\begin{aligned} \sin^{-1} \frac{1}{2} &= \frac{1}{i} \log \left(\frac{i}{2} \pm \frac{\sqrt{3}}{2} \right) \\ &= \frac{1}{i} \left[\log e^{i \left(\frac{\pi}{6} + 2k\pi \right)} \right] \text{ or } \frac{1}{i} \left[\log e^{i \left(\frac{5\pi}{6} + 2k\pi \right)} \right] \\ &= \frac{1}{i} \left[i \left(\frac{\pi}{6} + 2k\pi \right) \right] \text{ or } \frac{1}{i} \left[i \left(\frac{5\pi}{6} + 2k\pi \right) \right] \\ &= \frac{\pi}{6} + 2k\pi \text{ or } \frac{5\pi}{6} + 2k\pi, \text{ k is any integer.} \end{aligned}$$

Likewise, the set of values for other inverse trigonometric functions can be ascertained.

Example 22 : Discuss the mapping $\omega = \sinh z$ that transforms the infinite strip $-\infty < x < \infty$, $0 < y < \pi$ into the ω -plane. Find cuts in the ω -plane which make the mapping continuous both ways. What are the images of the lines (a) $y = 1/\pi$ (b) $x = 1$?

Solution : First we express $\sinh z$ in cartesian form

$$\omega = \sinh z = \sinh x \cos y + i \cosh x \sin y = u + iv$$

We consider the line segment $x = c$, $y \in (0, \pi)$. Its image is

$$\{\sinh c \cos y + i \cosh c \sin y | y \in (0, \pi)\}$$

Clearly, u and v then satisfy the equation for the ellipse

$$\frac{u^2}{\sinh^2 c} + \frac{v^2}{\cosh^2 c} = 1$$

The ellipse starts at the point $(\sinh c, 0)$, passes through the point $(0, \cosh c)$ and ends at $(-\sinh c, 0)$. As c varies from zero to ∞ or from zero to $-\infty$, the semi-ellipses cover the upper-half of ω -plane. Thus the mapping is 2-to-1.

Now consider the infinite line $y = c$, $x \in (-\infty, \infty)$.

It's image is $\{\sinh x \cos c + i \cosh x \sin c | x \in (-\infty, \infty)\}$.

Here u and v satisfy the equation for a hyperbola

$$\frac{u^2}{\cos^2 c} - \frac{v^2}{\sin^2 c} = 1$$

As c varies from 0 to $\pi/2$ or from $\pi/2$ to π , the semi-hyperbola cover the upper-half of ω -plane. Thus the mapping is 2-to-1.

We look for branch points of $\sinh^{-1}\omega$

$$\omega = \sinh z$$

$$\omega = \frac{e^z - e^{-z}}{2}$$

$$e^{2z} - 2\omega e^z - 1 = 0$$

$$e^z = \omega + (\omega^2 + 1)^{1/2}$$

$$z = \log(\omega + (\omega - i)^{1/2} (\omega + i)^{1/2})$$

The branch points are at $\omega = \pm i$. Since $\omega + (\omega^2 + 1)^{1/2}$ is non zero and finite in the finite complex plane, the logarithm does not introduce any branch in the finite plane. Thus the only branch point in the upper-half of ω -plane is at $\omega = i$. Any branch cut that connects $\omega = i$ with the boundary of $\text{Im } \omega > 0$ will separate the branches under the inverse mapping.

We consider the line $y = \pi/4$. The image under the mapping is the upper-half of the hyperbola

$$2u^2 - 2v^2 = 1$$

Consider the segment $x = 1$. The image under the mapping is the upper-half of the ellipse.

$$\frac{u^2}{\sinh^2 1} + \frac{v^2}{\cosh^2 1} = 1$$

Example 23 : Construct a Riemann Surface for $\cos^{-1}z$.

Solution : The function $\omega = \cos^{-1}z = -i \log [z + (z^2 - 1)^{1/2}]$ has two sources of multi-valuedness; one due to the square root function $(z^2 - 1)^{1/2}$ and the other due to the logarithm, if any.

First we construct the branch of the square root

$$(z^2 - 1)^{1/2} = (z + 1)^{1/2}(z - 1)^{1/2}$$

We see that there are branch points at $z = -1$ and $z = 1$. In particular we want the $\cos^{-1}z$ to be defined for $z = x$, $x \in [-1, 1]$. Hence we introduce the branch cuts on the lines $(-\infty, -1]$ and $[1, \infty)$. Let

$$z + 1 = re^{i\theta}, \quad z - 1 = \rho e^{i\phi}$$

With the given branch cuts, the angles have the possible ranges

$$-\pi \leq \theta < \pi, \quad 0 \leq \phi < 2\pi$$

Now we must determine if the logarithm introduces additional branch points. The only possibilities for branch points are where the argument of the logarithm is zero.

$$z + (z^2 - 1)^{1/2} = 0$$

$$\text{or, } z^2 = z^2 - 1 \Rightarrow 0 = -1$$

We see that the argument of the logarithm can not be zero and thus there are no additional branch points. Here the Riemann surface consists of two sheets S_0 and S_1 joined on the real axis $(-\infty, -1] \cup [1, \infty)$:

$$S_0 \begin{cases} 0 \leq \phi < 2\pi \\ -\pi \leq \theta < \pi \end{cases} \quad S_1 \begin{cases} 2\pi \leq \phi < 4\pi \\ \pi \leq \theta < 3\pi \end{cases}$$

A particular branch of this function can be obtained by first taking

$$z + 1 = re^{i\theta}, \quad -\pi \leq \theta < \pi; \quad z - 1 = \rho e^{i\phi}, \quad 0 \leq \phi < 2\pi$$

Then adding these relations, we find

$$z = (re^{i\theta} + \rho e^{i\phi})/2$$

and the function $z + (z^2 - 1)^{1/2}$ reduces to

$$\begin{aligned} z + (z^2 - 1)^{1/2} &= \frac{re^{i\theta} + \rho e^{i\phi}}{2} + (r\rho)^{1/2} e^{i(\theta+\phi)/2} \\ &= \frac{re^{i\theta}}{2} \left(1 + \frac{\rho}{r} e^{i(\phi-\theta)} + 2\sqrt{\frac{\rho}{r}} e^{i(\phi-\theta)/2} \right) \end{aligned}$$

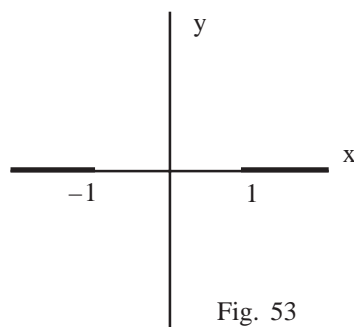

Fig. 53

$$= \frac{re^{i\theta}}{2} \left(1 + \sqrt{\frac{\rho}{r}} e^{i(\phi-\theta)/2} \right)^2$$

Then $\cos^{-1} z = -i \left\{ \log \left(\frac{r}{2} e^{i\theta} \right) + \log \left(1 + \sqrt{\frac{\rho}{r}} e^{i(\phi-\theta)/2} \right)^2 \right\}$ on S_0 . If a point lying on the

sheet S_0 is allowed to travel a path making a complete round about only the branch point $z = 1$, it enters to the sheet S_1 from the sheet S_0 . In this case the value of ϕ changes by 2π while the value of θ remains unchanged. The change in $(\phi-\theta)/2$ is π . So in this case,

$$\cos^{-1} z = -i \left\{ \log \left(\frac{r}{2} e^{i\theta} \right) + \log \left(1 - \sqrt{\frac{\rho}{r}} e^{i(\phi-\theta)/2} \right)^2 \right\} \text{ on } S_1. \text{ Similarly we can analyse}$$

the case when the point on S_0 encloses only the branch point $z = -1$ while travelling a complete round.

Some standard branch cuts of elementary functions.

Function	Branch cuts
z^s , non integral s with $\text{Re } s > 0$	$(-\infty, 0)$
z^s , non integral s with $\text{Re } s \leq 0$	$(-\infty, 0]$
e^z	none
$\log z$	$(-\infty, 0]$
$\sin^{-1}z, \cos^{-1}z$	$(-\infty, -1]$ and $[1, \infty)$
$\tan^{-1}z$	$y \leq -1, x = 0$ and $y \geq 1, x = 0$
$\text{cosec}^{-1}z, \sec^{-1}z$	$(-1, 1)$
$\cot^{-1}z$	$[-i, i]$
$\sinh^{-1}z$	$y < -1, x = 0$ and $y > 1, x = 0$
$\cosh^{-1}z$	$(-\infty, 1)$
$\text{cosech}^{-1}z$	$-1 < y < 1, x = 0$
$\text{sech}^{-1}z$	$(-\infty, 0]$ and $(1, \infty)$
$\tanh^{-1}z$	$y \leq 1, x = 0$ and $y \geq 1, x = 0$
$\text{coth}^{-1}z$	$[-1, 1]$

Exercises

1. Find the principal value of each of the following complex quantities :
(a) $(1 - i)^{1+i}$ (b) 3^{3-i} (c) 2^{2i}
2. Give the number of branches and locations of the branch points for the functions.
(a) $\cos(z^{1/2})$ (b) $(z + i)^{-z}$

3. Determine the branch points of the function

$$\omega = \{(z^2 - z)(z + 2)\}^{1/3}$$

4. Find the branch points of $(z^{1/2} - 1)^{1/2}$ in the finite complex plane. Introduce branch cuts to make the function single-valued.
5. Let D be the complex z -plane with a cut along the segment $[-1, 1]$, determine the regular branches of the function

$$f(z) = \left(\frac{1-z}{1+z} \right)^{1/2}$$

6. Split the function $f(z) = \sqrt{(z^2 - 4)(z^2 - 9)}$ into two regular branches in the domain $D : \mathbb{C} \setminus \{[-3, -2], [2, 3]\}$
7. Evaluate

$$(i) \int_0^\infty \frac{x^\alpha}{x^2 - 1} dx, \quad -1 < \alpha < 1 \quad (ii) \int_0^\infty \frac{\log x}{x^2 + 1} dx$$

8. Prove that $\int_0^\pi \log \sin x dx = -\pi \log 2$.

9. Construct a Riemann surface for the following functions :

$$(i) \omega = z^{1/3} \quad (ii) \omega = (z^2 + 1)^{1/2} \quad (iii) \omega = \log \frac{z+1}{z-1} \quad (iv) \omega = \sin^{-1}z.$$

10. Let $f(z)$ have branch points at $z = 0$ and $z = \pm i$ but nowhere else in the extended complex plane. How does the value and argument of $f(z)$ change while traversing the contour given in the figures 51(a) (b). Do the branch cuts make the function single valued?

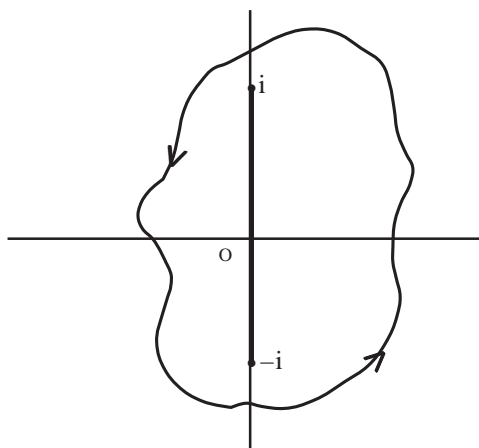

Fig. 54 (a)

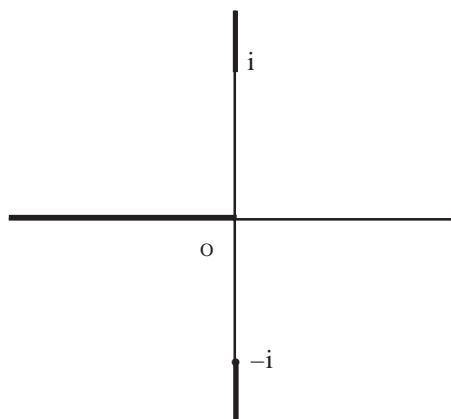

Fig. 54 (b)

Unit 5 □ Conformal Equivalence

Structure

5.0 Objectives

5.1 Riemann Mapping Theorem

5.2 The Schwarz Reflection Principle

5.3 The Schwarz-Christoffel Transformation

5.4 Examples : Triangles / Rectangles

5.0 Objectives of this Chapter

The concept of conformal equivalence of two regions will be introduced in this chapter. The main theorem of this chapter is Riemann mapping theorem. Also Hurwitz's theorem, Schwarz lemma, Schwarz reflection principle, Schwarz-Christoffel transformation will be studied and their applications will be shown through a few examples.

5.1 Riemann Mapping Theorem

In the family of analytic functions that concern geometrical orientation, conformal mapping plays a leading role. As its consequences we shall present here a most important result named after G. F. B Riemann, known as "Riemann mapping theorem". Throughout $H(G)$ will denote the family of analytic functions defined on the region G .

Definition : Conformal Equivalence :

Two regions R_1 and R_2 are said to be conformally equivalent if there exists a $f \in H(R_1)$ such that f is one-to-one in R_1 and $f(R_1) = R_2$ i.e. if there exists a conformal mapping one to one of R_1 onto R_2 . Clearly, this is an equivalence relation (reflexive, symmetric and transitive).

Theorem 5.1 [Hurwitz's Theorem] Let G be a region and $\{f_n\}$ be a sequence in $H(G)$ that converges uniformly to $f \in H(G)$. Suppose $f \neq 0$, $\overline{D}(a, R) \subset G$ and $f(z) \neq 0$ on $\gamma : |z-a| = R$. Then there exists an integer N such that for $n \geq N$, f_n and f have the same number of zeros in $D(a, R)$.

Proof. Since $f(z)$ is never zero on the circle γ , we have

$$\inf_{\gamma} |f(z)| = \delta > 0$$

Again, $f_n \rightarrow f$ uniformly on γ , so there is an integer N such that for $n \geq N$

$$\sup_{\gamma} |f_n(z) - f(z)| < \frac{\delta}{2}$$

and thus on the circle γ , $|f(z) - f_n(z)| < \frac{\delta}{2} < \delta \leq |f(z)|$ for $n \geq N$. Using Rouché's theorem we find that f_n and f have the same number of zeros inside the circle $\gamma : |z-a| = R$ for $n \geq N$.

By means of the above theorem, we can easily prove

Corollary 1. Let G be a region and $\{f_n\}$ be a sequence in $H(G)$ such that each f_n never vanishes in G . Suppose $f_n \rightarrow f$ uniformly in $H(G)$. Then $f(z)$ never vanishes in G , unless $f \equiv 0$.

Some useful results

(i) If $f(z)$ is analytic at z_0 and $f'(z_0) \neq 0$, then there is a neighbourhood of z_0 in which $f(z)$ is univalent.

(ii) An univalent analytic function f on a domain G has a non-zero derivative at every point of G , i.e., $f'(z) \neq 0$ on G .

(iii) The inverse of an univalent analytic function is analytic.

(iv) Any domain in \mathcal{C} , that is conformally equivalent to a simply connected domain must itself be simply connected.

(v) A domain D in \mathcal{C} is simply connected if and only if every analytic function in D has a primitive in D .

Schwarz Lemma

Let $f : D(0, 1) \rightarrow D(0, 1)$ be an analytic function which maps the unit disc $D(0, 1)$ to itself. If $f(0) = 0$,

then

(i) $|f(z)| \leq |z|$ for $0 \leq |z| < 1$

(ii) $|f'(0)| \leq 1$

(iii) if equality holds in (i) for at least one $z \in D(0, 1) - \{0\}$, or, if equality holds in (ii), then

$$f(z) = \lambda z,$$

where λ is a constant, $|\lambda| = 1$.

Proof : Let us consider the function

$$g(z) = \frac{f(z)}{z}$$

which is analytic in the disc $D(0, 1) - \{0\}$ and it has removable singularity at $z = 0$, since $f(0) = 0$. It can be made analytic at $z = 0$ if we define

$$g(0) = \lim_{z \rightarrow 0} \frac{f(z)}{z} = f'(0) \quad (55)$$

For $|z| = r$, where $0 < r < 1$

$$|g(z)| = \frac{|f(z)|}{|z|} < \frac{1}{r}$$

By the Maximum Modulus Principle, $|g(z)| < 1/r$ for the entire disc $|z| \leq r$. We fix $z \in D(0, 1) - \{0\}$ and let $r \rightarrow 1$. Then

$$|g(z)| \leq 1.$$

This is true for all $z \in D(0, 1) - \{0\}$ and we get

$$\frac{|f(z)|}{|z|} \leq 1, \quad 0 < |z| < 1 \quad (56)$$

i.e. $|f(z)| \leq |z|$, $0 < |z| < 1$. Since $f(0) = 0$, we have $|f(z)| \leq |z|$ for $0 \leq |z| < 1$. So,

(i) is proved and we find from (55) that $|g(0)| = |f'(0)| \leq 1$ which proves (ii)

To prove (iii), we observe that if at a point $z_0 \neq 0$ ($|z_0| < 1$) $|g(z_0)| = 1$ i.e. $|g(z)|$ attains its maximum at an internal point and hence by the maximum modulus principle $g(z) = \lambda$, a constant and that $|\lambda| = 1$, so $f(z) = \lambda z$.

Theorem 5.2 Let $a \in D(0, 1)$. Then ϕ_a defined by

$$\phi_a(z) = \frac{z - a}{1 - \bar{a}z}$$

maps $\bar{D}(0, 1)$ onto $\bar{D}(0, 1)$.

Proof. Clearly, ϕ_a is a bilinear transformation, it is analytic in the whole complex plane except the point $\frac{1}{\bar{a}}$ (which is the inverse point of the point a with respect to the circle $|z| = 1$, and hence lies outside $|z| = 1$). We observe that

$$\begin{aligned} \phi_a(\phi_{-a}(z)) &= \frac{\frac{z+a}{1+\bar{a}z} - a}{1 - \bar{a} \frac{z+a}{1+\bar{a}z}} \\ &= \frac{z(1-|a|^2)}{1-|a|^2} \\ &= z = \phi_{-a}(f_a(z)), \text{ similarly.} \end{aligned}$$

Thus ϕ_a maps $D(0, 1)$ onto $D(0, 1)$ in a one to one way. Now let θ be a real number. Then

$$\begin{aligned} |\phi_a(e^{i\theta})| &= \left| \frac{e^{i\theta} - a}{1 - \bar{a}e^{i\theta}} \right| \\ &= \left| \frac{e^{i\theta} - a}{e^{-i\theta} - \bar{a}} \right| \left| \frac{1}{e^{i\theta}} \right| = \left| \frac{e^{i\theta} - a}{e^{i\theta} - a} \right| = 1 \end{aligned}$$

i.e., ϕ_a maps $|z| = 1$ on $|z| = 1$. Thus, ϕ_a maps $\bar{D}(0, 1)$ onto $\bar{D}(0, 1)$.

A maximal problem

Let α, β be two complex numbers with $|\alpha| < 1, |\beta| < 1$ and f be analytic on $D(0, 1)$ satisfying $f(\alpha) = \beta$. What is the maximum possible value of $|f'(\alpha)|$ among such mappings?

Solution : Let

$$g = \phi_\beta \circ f \circ \phi_{-\alpha} \text{ where } \phi_\beta \text{ is defined as in theorem 5.2} \quad (57)$$

Then g maps $D(0, 1)$ to $D(0, 1)$ and satisfies

$$\begin{aligned} g(0) &= \phi_\beta \{f(\phi_{-\alpha}(0))\} \\ &= \phi_\beta \{f(\alpha)\} \\ &= \phi_\beta(\beta) \\ &= 0 \end{aligned}$$

Thus g satisfies all the conditions of Schwarz's lemma and hence $|g'(0)| \leq 1$. To obtain an explicit form of $g'(0)$, we use (57) and apply the chain rule

$$\begin{aligned} g'(0) &= \{(\phi_\beta \circ f)'(\phi_{-\alpha}(0))\} \phi_{-\alpha}'(0) \\ &= (\phi_\beta \circ f)'(\alpha) (1 - |\alpha|^2) \\ &= \phi_\beta'(f(\alpha)) f'(\alpha) (1 - |\alpha|^2) \\ &= \phi_\beta'(\beta) f'(\alpha) (1 - |\alpha|^2) \\ &= \frac{1 - |\alpha|^2}{1 - |\beta|^2} f'(\alpha) \end{aligned}$$

But $|g'(0)| \leq 1$, therefore

$$|f'(\alpha)| \leq \frac{1 - |\beta|^2}{1 - |\alpha|^2} \quad (58)$$

Equality in (58) occurs only when $|g'(0)| = 1$. In that case by virtue of Schwarz

lemma there is a constant λ , $|\lambda| = 1$ so that $g(z) = \lambda z$. Hence,

$$f(z) = \phi_{-\beta} \{ \lambda \phi_{\alpha}(z) \}, \quad z \in D(0, 1) \quad (59)$$

We now present an important consequence of Schwarz's lemma, which may be seen as the converse form of theorem 5.2.

Theorem 5.3 : Let $f : D(0, 1) \rightarrow D(0, 1)$ be any conformal map of the unit disc onto itself and $f(a) = 0$, $a \in D(0, 1)$. Then there is a constant λ , $|\lambda| = 1$ such that

$$f(z) = \lambda \phi_a(z) \text{ where } \phi_a \text{ is defined as in theorem 5.2.}$$

Proof. Since f is a conformal map from $D(0, 1)$ to $D(0, 1)$, we can have inverse of f , g defined by

$$g \{ f(z) \} = z,$$

which is analytic too. Applying the chain rule

$$g'(0) f'(a) = 1 \quad (60)$$

But according to inequality (58), f and g have to satisfy

$$|f'(a)| \leq \frac{1}{1-|a|^2}, \quad |g'(0)| \leq 1-|a|^2 \quad (61)$$

(since, $f(a) = 0$ and $g(0) = a$).

From (60), (61) it follows that $|f'(a)| = (1-|a|^2)^{-1}$. Hence applying the result (59) we find that

$$f(z) = \lambda \phi_a(z)$$

for some λ with $|\lambda| = 1$.

Lemma 5.1 : Let G be a simply connected region and $\{f_n\}$ be a sequence of injective analytic mappings (conformal mappings) of G into \mathcal{C} which converges uniformly on every compact subset of G , then the limit function f is either constant or injective.

Proof. Suppose f is not constant and not injective. Then there exist two points ζ and $\eta \in G$, $\zeta \neq \eta$ such that $f(\zeta) = f(\eta) = \omega_0$, say.

Let $g_n(z) = f_n(z) - \omega_0$. We can find a positive δ , $\delta < |\zeta - \eta|/2$ so that the discs $D(\zeta, \delta)$ and $D(\eta, \delta)$ are included in G . Now $g(z) = f(z) - \omega_0$ never vanishes on the circles $|z - \zeta| = \delta$ and $|z - \eta| = \delta$, where $g(z) = \lim_{n \rightarrow \infty} g_n(z)$. Applying Hurwitz's theorem, for large n , there exists ζ_n lying inside the circle $|z - \zeta| = \delta$ with $g_n(\zeta_n) = 0$ as $g_n \rightarrow g$ uniformly in G . Similarly, for all large n , there is η_n within $|z - \eta| = \delta$ with $g_n(\eta_n) = 0$. But by construction, $D(\zeta, \delta) \cap D(\eta, \delta) = \emptyset$ and hence $\zeta_n \neq \eta_n$. Thus

$$g_n(\zeta_n) = g_n(\eta_n) = 0, \quad \zeta_n \neq \eta_n$$

that is,

$$f_n(\zeta_n) = f_n(\eta_n), \quad \zeta_n \neq \eta_n$$

contradicting the injectivity of each f_n and the proof follows.

NOTE : There is no conformal map f of the unit disc $D(0, 1)$ onto the whole complex plane \mathcal{C} because then the inverse function $f^{-1} : \mathcal{C} \rightarrow D(0, 1)$ would be a bounded entire function which is not constant, contradicting the Liouville's theorem.

Open mapping theorem : Let G be a region and suppose that f is a non-constant analytic function on G . Then for any open set U in G , $f(U)$ is open.

Proof : Omitted.

Uniform boundedness : A sequence of functions $\{f_n\}$ defined on a set D is said to be uniformly bounded on D if there exists a constant $M > 0$ such that $|f_n(z)| \leq M$ for all n and for all $z \in D$.

Normal family : Let F be a family of functions in a region G . The family F is said to be normal in G if every sequence $\{f_n\}$ of functions $f_n \in F$ contains a subsequence $\{f_{n_k}\}$ which converges uniformly on every compact subset of G .

Montel's theorem : A family F in $H(G)$ is normal if and only if F is uniformly bounded on every compact subset of G .

Proof : Omitted.

Theorem 5.4 : [Riemann Mapping Theorem] Let G be a simply connected region, except for \mathcal{C} itself and let $a \in G$. Then there is a unique conformal map $f : G \rightarrow D(0, 1)$ of G onto the unit disc which satisfies

$$f(a) = 0 \text{ and } f'(a) > 0.$$

Proof. Let us first prove that f is unique. If there was another conformal map $g : G \rightarrow D(0, 1)$ with the given properties, then

$$f \circ g^{-1} : D(0, 1) \rightarrow D(0, 1)$$

would be a conformal map and also

$$(f \circ g^{-1})(0) = f(a) = 0$$

Hence, applying Theorem 5.3, we find that there is a constant λ with $|\lambda| = 1$

$$(f \circ g^{-1})(z) = \lambda z$$

Deriving the derivative at the origin, we find

$$(f \circ g^{-1})'(0) = f'(g^{-1}(0))(g^{-1})'(0) = f'(a) \frac{1}{g'(g^{-1}(0))} = \frac{f'(a)}{g'(a)} > 0,$$

from which it follows that λ is positive. But also $|\lambda| = 1$, so $\lambda = 1$. Thus $f \circ g^{-1}$ is an identity map and $f = g$.

The proof of existence is divided into several stages.

Lemma 5.2 Let G be a simply connected region other than \mathcal{C} . Then there exists an injective analytic map f on G with $f(G) \subset D(0, 1)$.

Proof. We choose a point $b \in \mathcal{C} \setminus G$. Since G is simply connected there exists a $g : G \rightarrow \mathcal{C}$ analytic with $g^2(z) = z - b$.

Here g is injective since

$$\begin{aligned} & g(z_1) = g(z_2) \\ \Rightarrow & g^2(z_1) = g^2(z_2) \\ \text{i.e.} & z_1 - b = z_2 - b \\ \Rightarrow & z_1 = z_2. \end{aligned}$$

By open mapping theorem $g(G)$ is open. Let us pick $\omega_0 \in g(G)$ and choose $r > 0$ so that $D(\omega_0, r) \subset g(G)$. Then $D(-\omega_0, r) \subset \mathbb{C} \setminus g(G)$. For, if there exists a point $\omega \in D(-\omega_0, r) \cap g(G)$, then $\omega = g(z_1)$ for some $z_1 \in G$ and also $-\omega \in D(\omega_0, r) \subset g(G)$, so that $-\omega = g(z_2)$ for some $z_2 \in G$. Again,

$$\begin{aligned} & g(z_1) = -g(z_2) \\ \Rightarrow & g^2(z_1) = g^2(z_2) \\ \text{or,} & z_1 - b = z_2 - b \\ \text{i.e.} & z_1 = z_2 \\ \text{or,} & g(z_1) = g(z_2) = -g(z_1) \\ \Rightarrow & g(z_1) = 0 \\ \Rightarrow & 0 = g^2(z_1) = z_1 - b \\ \text{i.e.} & z_1 = b \in \mathbb{C} \setminus G \end{aligned}$$

contradicting $z_1 \in G$.

$$\text{We take } f(z) = \frac{r}{2[g(z) + \omega_0]} \quad (62)$$

Then f is injective analytic map on G (by construction $|g(z) + \omega_0| \geq r$ for $z \in G$) and also satisfies $|f(z)| \leq \frac{1}{2} < 1$ for $z \in G$.

Lemma 5.3 : Let G be a simply connected region other than \mathbb{C} itself and let $a \in G$ be fixed. Then there exists a conformal map $f : G \rightarrow D(0, 1)$ of G onto the unit disc with the properties $f(z) = 0$ and $f(a) > 0$.

Proof : Let F denote the family of analytic functions $f : G \rightarrow \mathbb{C}$ such that either $f \equiv 0$ or f is injective, and $f(G) \subset (0, 1)$, $f(a) = 0$ and $f'(a) > 0$.

Let us consider the function

$$\psi(z) = \frac{f(z) - f(a)}{1 - \overline{f(a)} f(z)}$$

where $f(z)$ is given by (62) of lemma 5.2 and we find that $\psi(G) \subset D(0, 1)$, $\psi(a) = 0$ and $\psi'(a) > 0$. So F is non empty and by Montel's theorem it is normal. Applying Lemma 1 we see that all functions in the closure of F in $H(G)$ are either constant or injective. Now since all functions in F take the value zero at a , the same is true for all functions in the closure of F . Likewise the only constant function in the closure is

0 while the other functions in the closure satisfy $f(G) \subset \overline{D}(0, 1)$. Since $f(G)$ is open, by open mapping theorem, $f(G) \subset D(0, 1)$. Again since the $f \rightarrow f^1(a)$ is continuous, all functions in the closure of F must satisfy $f^1(a) \geq 0$. The functions in the closure, that are not identically zero, are injective, so $f^1(a) > 0$ unless $f \equiv 0$. These observations prove that the set F is closed in $H(G)$. Hence F is compact in $H(G)$.

Since the map $f \rightarrow f^1(a) : F \rightarrow \mathbb{R}$ is a continuous function on a compact set, it must attain its maximum value, as we are not considering constant function (here it is zero). Let $f \in F$ be a function with $f^1(a)$ maximum.

We now show that $f(G) = D(0, 1)$. On the contrary, suppose that $f(G) \neq D(0, 1)$ and choose $w \in D(0, 1) \setminus f(G)$. Using the property that every non-vanishing analytic function in a simply connected region has an analytic square root, we take a function $h \in H(G)$ with

$$[h(z)]^2 = \frac{f(z) - \omega}{1 - \overline{\omega}f(z)} \quad (63)$$

Now as the bilinear transformation $\phi_a(z) = \frac{z - a}{1 - \overline{a}z}$ maps $D(0, 1)$ onto $D(0, 1)$

and as $f \in F$, $h(G) \subset D(0, 1)$.

Let $g : G \rightarrow \mathbb{C}$ defined by

$$g(z) = \frac{|h^1(a)|}{h^1(a)} \cdot \frac{h(z) - h(a)}{1 - \overline{h(a)}h(z)}$$

Then clearly, $g(G) \subset D(0, 1)$, $g(a) = 0$ and g is analytic injective and $g^1(a) > 0$, since

$$\begin{aligned} g^1(a) &= \frac{|h^1(a)|}{h^1(a)} \cdot \frac{h^1(a)[1 - |h(a)|^2]}{[1 - |h(a)|^2]^2} \\ &= \frac{|h^1(a)|}{1 - |h(a)|^2} > 0 \end{aligned} \quad (64)$$

So, $g \in F$.

Again, differentiating (63) we find that

$$2h(a)h^1(a) = f^1(a)(1 - |\omega|^2)$$

So, from (64)

$$g^1(a) = \frac{|h(a)||h^1(a)|}{|h(a)|(1 - |h(a)|^2)} = \frac{f^1(a)(1 - |\omega|^2)}{2\sqrt{\omega}(1 - |\omega|)}, \text{ as } |h(a)|^2 = |\omega|$$

$$= \frac{f'(a)(1 + |\omega|)}{2\sqrt{\omega}} > f'(a).$$

contradicting the choice of $f \in F$ as maximising $f'(a)$. Thus $f(G) = D(0, 1)$.

Note : The Riemann mapping theorem is one of the most celebrated results of complex analysis. It is the beginning of the study of complex analysis from a geometric view point. G. F. B. Riemann in 1851 correctly formulated the theorem, but unfortunately his proof of the theorem was lacking. According to various accounts, he assumed but did not prove that a certain maximal problem had a solution. A final proof was definitely known by the early 20th century, different sources attributed to it particularly, W. F. Osgood, P. Koebe, L Bieberbach etc.

5.2 The Schwarz Reflection Principle

Let f be analytic in the domains D_1, D_2 which have a common piece of boundary, a smooth curve γ . Assume further that f is continuous across γ . Then, by Morera's theorem, f is analytic in $D_1 \cup D_2$. This allows us to perform analytic continuation in some cases.

Theorem 5.5 [The Schwarz reflection principle] Given a function $f(z)$ analytic in a domain D lying in the upper half plane whose boundary contains a segment $I \subset \mathbb{R}$, assume f is continuous on $D \cup I$ and real-valued on I . Then f has analytic continuation across I , in a domain $D \cup I \cup D^*$, where $D^* = \{\bar{z} : z \in D\}$.

Proof. Let us consider the function

$$f(z) = \begin{cases} f(z), & z \in D \cup I \\ f(\bar{z}), & z \in D^* \cup I \end{cases}$$

It is clear that F is analytic in D . We shall show that F is also analytic in D^* . Let z and $z + h$ lie within D^* . Then \bar{z} and $\bar{z} + \bar{h}$ lie within D and we can express.

$$\lim_{h \rightarrow 0} \frac{F(z+h) - F(z)}{h} = \lim_{h \rightarrow 0} \frac{\overline{f(\bar{z} + \bar{h})} - \overline{f(\bar{z})}}{h} = \lim_{h \rightarrow 0} \left[\frac{f(\bar{z} + \bar{h}) - f(\bar{z})}{h} \right] = \overline{f'(\bar{z})}.$$

So, F is analytic in D^* . F is also continuous on $D^* \cup I$.

For, $z \in I$

$$\lim_{z \rightarrow x} F(z) = \lim_{z \rightarrow x} \overline{f(\bar{z})} = \overline{f(x)} = f(x),$$

by hypothesis. Thus F is continuous on $D \cup I \cup D^*$. To prove F is also analytic there, we consider the function

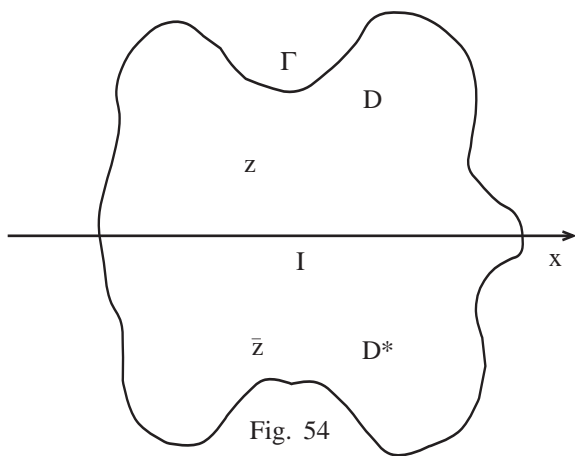

$$\phi(z) = \frac{1}{2\pi i} \int_{\Gamma} \frac{F(\zeta)}{\zeta - z} d\zeta \quad (65)$$

It is analytic in $D \cup I \cup D^*$ [as (i)]

$\frac{F(\zeta)}{\zeta - z}$ is continuous function of both variables when z lies within Γ and ζ on Γ .

(ii) for each such ζ , $\frac{F(\zeta)}{\zeta - z}$ is analytic in z in $D \cup I \cup D^*$. [see (14)].

To complete the proof, we try to establish $\phi(z) = F(z)$ for all $z \in D \cup I \cup D^*$.

Breaking the integral in (65) and adding the two integrals along I , which are in opposite directions, we write

$$\phi(z) = \frac{1}{2\pi i} \int_{\Gamma_1} \frac{F(\zeta)}{\zeta - z} d\zeta + \frac{1}{2\pi i} \int_{\Gamma_2} \frac{F(\zeta)}{\zeta - z} d\zeta \quad (66)$$

where Γ_1 and Γ_2 are the boundary of $D \cup I$ and $D^* \cup I$ respectively. When $z \in D \cup I$, the second integral in (66) vanishes and $\phi(z) = F(z)$. Again, the first integral vanishes when $z \in D^* \cup I$ and $\phi(z) = F(z)$ in this case too. Thus $\phi(z) = F(z)$ for all $z \in D \cup I \cup D^*$ and we have found a function $F(z)$, analytic in $D \cup I \cup D^*$, and coincides with $f(z)$ in $D \cup I$.

5.3 The Schwarz-Christoffel Transformation

We know from Riemann's mapping theorem that there is a conformal mapping which maps a given simply connected domain onto another simply connected domain, or equivalently onto the unit disc. But it does not help us to determine such mappings.

Many applications in boundary-value problem requires construction of one-to-one conformal mapping from the upper half plane $\text{Im } z > 0$ onto a polygon Ω in the w -plane. Two German mathematicians H. A. Schwarz and E. B. Christoffel independently discovered a method for finding such mappings during the years 1864-1869.

Theorem 5.6 [Schwarz and Christoffel] Let P be a polygon with vertices w_1, \dots, w_k in the anticlockwise direction and interior angles $\alpha_1\pi, \dots, \alpha_k\pi$ respectively, where $-1 < \alpha_1, \dots, \alpha_k < 1$. Then there exists a one-to-one conformal mapping of the form

$$f(z) = A \int_{z_0}^z (s - x_1)^{\alpha_1 - 1} (s - x_2)^{\alpha_2 - 1} \dots (s - x_{k-1})^{\alpha_{k-1} - 1} ds + B \quad (67)$$

where $A, B \in \mathcal{C}$, that maps the upper plane $\text{Im } z > 0$ onto the interior of P , with

$$f(x_1) = w_1, \dots, f(x_{k-1}) = w_{k-1}, f(\infty) = w_k. \quad (68)$$

Remarks : (i) We do not need to have specific information on w_k and α_k . While travelling the polygon anticlockwise direction we made a left turn of an angle $\pi - \alpha_j$ at the vertex ω_j .

(ii) Sometimes certain infinite regions can be thought of as infinite polygons. In this case it is convenient to take w_k as the point at infinity, as we need no information on α_k .

(iii) It can be shown that Schwarz-Christoffel transformation can be uniquely determined by three points as in the case of bilinear transformation. One of these is used by taking $f(\infty) = \omega_k$. We can therefore have the freedom to choose two points say, x_1 and x_2 satisfying $-\infty < x_1 < x_2 < \infty$.

(iv) Note that the integral involved may be impossible to calculate theoretically. In practical problems numerical techniques are often used to evaluate the integral. In first part of the proof we take $f(x_k) = \omega_k$, $x_k = \text{finite}$.

Proof. By Riemann mapping theorem such a mapping exists. We shall prove that its form is given by (67). So $f(z)$ is analytic for $\text{Im } z > 0$ and $f'(z) \neq 0$ in the upper half plane. From these it is clear that

$$\frac{d}{dz} \log f'(z) = \frac{f''(z)}{f'(z)}$$

is analytic in the upper half plane. To construct the function $f(z)$ our aim is to establish that $f''(z)/f'(z)$ is analytic for $\text{Im } z \geq 0$ save for the pre-image points of the vertices of the polygon lying on the real axis.

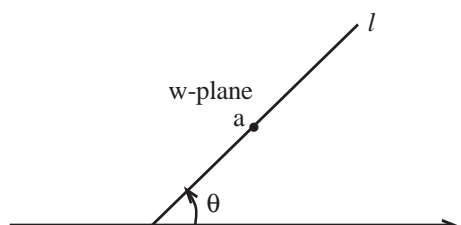

Fig. 55

Let l be a side of the polygon P , which makes an angle θ (positive sense) with the real-axis and ζ be any point on l but not a vertex of the polygon P . Then for any ω on l , $(\omega - \zeta)e^{-i\theta}$ is

real and there is a point z on the real axis of the z -plane so that $f(z) = \omega$ and a corresponding point $z = a$ for ζ on the same line. Hence

$$\{f(z) - \zeta\}e^{-i\theta}$$

is real and continuous on the segment γ of the real axis of the z -plane corresponding to the straight line l of the ω -plane. Moreover, this function is also analytic for $\text{Im } z > 0$, thus following the Schwarz reflection principle we can continue this function analytically across γ to the lower half plane $\text{Im } z < 0$. In particular, this function is analytic in a neighbourhood of the point $z = a$ and can be expanded in the form of the Taylor series.

$$\{f(z) - \zeta\}e^{-i\theta} = \sum_{k=1}^{\infty} c_k (z - a)^k$$

where $c_1 = f'(a) \neq 0$, maintaining the status quo that $f(a) = \zeta$ and the function f maps the segment γ onto the straight line l . Now

$$f'(z) = e^{i\theta}\{c_1 + 2c_2(z - a) + \dots\}$$

and $\log f'(z) = i\theta + \log\{c_1 + 2c_2(z - a) + \dots\}$

So, $\frac{d}{dz} \log f^1(z)$ is analytic in a neighbourhood of $z = a$ and real on a real line segment intercepted by the neighbourhood.

Let us consider the case when the point ζ is the corresponding point at infinity on γ (in this case γ is divided into two parts, each of infinite length). Here the Taylor series expansion in the neighbourhood of point at infinity

$$\{f(z) - \zeta\}e^{-i\theta} = \sum_{k=1}^{\infty} c_k / z^k$$

where each c_R is real and $c_1 \neq 0$ (with the same reason mentioned in the finite case). So

$$f'(z)e^{-i\theta} = -\frac{c_1}{z^2} - \frac{2c_2}{z^3} - \frac{3c_3}{z^4} - \dots$$

$$f''(z)e^{-i\theta} = \frac{2c_1}{z^3} + \frac{6c_2}{z^4} + \frac{12c_3}{z^5} + \dots$$

and we find that

$$\begin{aligned} \frac{f''(z)}{f'(z)} &= \frac{z^{-3} \left\{ 2c_1 + \frac{6c_2}{z} + \frac{12c_3}{z^2} + \dots \right\}}{-c_1 z^{-2} \left\{ 1 + \frac{2c_2/c_1}{z} + \dots \right\}} = -\frac{1}{c_1} \left\{ 2c_1 + \frac{6c_2}{z} + \dots \right\} \left\{ 1 - \frac{2c_2/c_1}{z} + \dots \right\} \\ &= -\frac{2}{z} + \sum_{k=2}^{\infty} \frac{\tilde{c}_k}{z^k} \end{aligned} \quad (69)$$

$\frac{d}{dz} \log f^1(z)$ is analytic in a neighbourhood of the point at infinity and is real when z is real.

In the polygon P , let ℓ^1 be an adjacent side to ℓ making on angle $\alpha_1\pi$ at their point of intersection ω_1 . The corresponding point of ω_1 on the real axis is x_1 . Here

the function $f(z)$ is not analytic in a neighbourhood of x_1 , we choose the branch of the argument so that

$$\frac{\pi}{2} < \text{Arg}(z - x_1) < \frac{3\pi}{2}$$

introducing a branch cut along the axis $\{x_1 + iy : y \leq 0\}$ [$f(z)$ is not continuous on this branch cut].

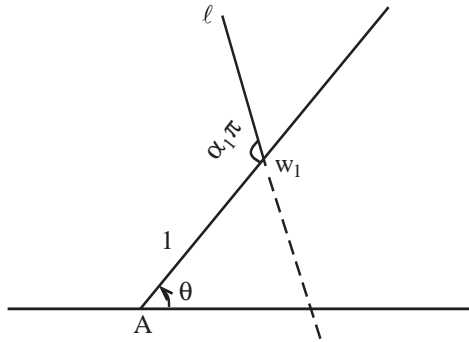

Fig. 56

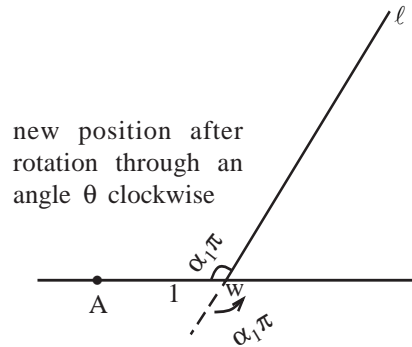

Fig. 57

Here $\text{Arg} \{(\omega_1 - \omega)e^{-i\theta}\}$ is equal to zero or $\alpha_1\pi$ according as ω lies on ℓ or ℓ^1 . So the function

$$[\{\omega_1 - f(z)\}e^{-i\theta}]^{1/\alpha_1}$$

is real and continuous on the segment of the real axis corresponding to the consecutive sides ℓ and ℓ^1 . Again this function is analytic for $\text{Im } z > 0$ since $f(z) - \omega_1$ is analytic and non zero there.

Expanding $[\{\omega_1 - f(z)\}e^{-i\theta}]^{1/\alpha_1}$ in Taylor's series in a neighbourhood of x_1 we find

$$[\{\omega_1 - f(z)\}e^{-i\theta}]^{1/\alpha_1} = \sum_{k=1}^{\infty} c_k (z - x_1)^k$$

where each c_k is real and $c_1 \neq 0$. On simplifying, we find

$$\begin{aligned} f(z) &= \omega_1 - e^{i\theta} (z - x_1)^{\alpha_1} [c_1 + c_2(z - x_1) + \dots]^{\alpha_1} \\ &= \omega_1 + e^{i\theta} (z - x_1)^{\alpha_1} \sum_{k=0}^{\infty} c_k^1 (z - x_1)^k \end{aligned}$$

where c_0^1 is a constant multiple of c_1 , hence not equal to zero. Now we have

$$\begin{aligned} f'(z) &= e^{i\theta} (z - x_1)^{\alpha_1 - 1} [\alpha_1 c_0^1 + (\alpha_1 + 1)c_1^1 (z - x_1) + \dots] \\ &= (z - x_1)^{\alpha_1 - 1} F(z) \end{aligned}$$

where $F(z)$ is analytic and not zero in a neighbourhood of $z = x_1$ and we obtain

$$\frac{d}{dz} \log f^1(z) = \frac{\alpha_1 - 1}{z - x_1} + \frac{F^1(z)}{F(z)} \quad (70)$$

This shows that if the polygon P has an angle $\alpha_1\pi$ at a point ω_1 then $\frac{d}{dz} \log f^1(z)$ will have a simple pole of residue $\alpha_1 - 1$ at its corresponding point x_1 .

Now if the point at infinity be the corresponding point to ω_1 at which the polygon P has an angle $\alpha_1\pi$, then we can express

$$\left[\{\omega_1 - f(z)\} e^{-i\theta} \right]^{1/\alpha_1} = \frac{c_1}{z} + \frac{c_2}{z^2} + \dots$$

or,

$$f(z) = \omega_1 - e^{i\theta} \left(\frac{c_1}{z} \right)^{\alpha_1} \left(1 + \alpha_1 \frac{c_2}{zc_1} + \dots \right)$$

$$f'(z) = +e^{i\theta} \alpha_1 \frac{c_1^{\alpha_1}}{z^{\alpha_1+1}} \left(1 + \alpha_1 \frac{c_2}{zc_1} + \dots \right) - e^{i\theta} \left(\frac{c_1}{z} \right)^{\alpha_1} \left(-\frac{\alpha_1 c_2}{z^2 c_1} - \dots \right)$$

$$= e^{i\theta} c_1^{\alpha_1} \frac{\alpha_1}{z^{\alpha_1+1}} \left[1 + (\alpha_1 + 1) \frac{c_2}{zc_1} + \dots \right]$$

$$f''(z) = -e^{i\theta} c_1^{\alpha_1} \frac{\alpha_1(\alpha_1 + 1)}{z^{\alpha_1+2}} \left\{ 1 + (\alpha_1 + 1) \frac{c_2}{zc_1} + \dots \right\} + e^{i\theta} c_1^{\alpha_1} \frac{\alpha_1}{z^{\alpha_1+1}} \left\{ -(\alpha_1 + 1) \frac{c_2}{z^2 c_1} - \dots \right\}$$

$$= -e^{i\theta} c_1^{\alpha_1} \frac{\alpha_1(\alpha_1 + 1)}{z^{\alpha_1+2}} \left[1 + (\alpha_1 + 2) \frac{c_2}{zc_1} + \dots \right]$$

$$\frac{d}{dz} \log f'(z) = \frac{f''(z)}{f'(z)} = -\frac{\alpha_1 + 1}{z} \left\{ 1 + (\alpha_1 + 2) \frac{c_2}{zc_1} + \dots \right\} \left\{ 1 - (\alpha_1 + 1) \frac{c_2}{zc_1} + \dots \right\}$$

$$= -\frac{\alpha_1 + 1}{z} \left\{ 1 + (\alpha_1 + 2 - \alpha_1 - 1) \frac{c_2}{zc_1} + \dots \right\}$$

$$= -\frac{\alpha_1 + 1}{z} + \sum_{k=2}^{\infty} \frac{\tilde{c}_k}{z^k} \quad (71)$$

Now since x_2, x_3, \dots, x_k are the corresponding points lying on the real-axis of the z -plane, to the vertices w_2, w_3, \dots, w_k respectively of the polygon P with angles $\alpha_2\pi$,

$\alpha_3\pi, \dots, \alpha_k\pi$ there, the function $\frac{d}{dz} \log f^1(z)$ will have simple poles with residue $\alpha_j - 1$ at $x_j, j = 2, \dots, k$. Thus we see that this function is analytic for $\text{Im } z > 0$ and continuous on $\text{Im } z = 0$ except the points x_1, x_2, \dots, x_k and using the Schwarz reflection principle it can be continued analytically across the real axis. Hence $\frac{d}{dz} \log f^1(z)$ possesses only simple poles at x_1, x_2, \dots, x_k as its only singularities and can be expressed as

$$\frac{d}{dz} \log f^1(z) = \frac{\alpha_1 - 1}{z - x_1} + \frac{\alpha_2 - 1}{z - x_2} + \dots + \frac{\alpha_k - 1}{z - x_k} + G(z) \quad (72)$$

where $G(z)$ is a polynomial.

When $|z|$ is large enough

$$\frac{\alpha_i - 1}{z - x_i} = \frac{\alpha_i - 1}{z} \left(1 + \frac{x_i}{z} + \frac{x_i^2}{z^2} + \dots \right), i = 1, \dots, k$$

$$\begin{aligned} \text{So, } \frac{d}{dz} \log f^1(z) &= \sum_{i=1}^k (\alpha_i - 1) / z + \sum_{i=1}^k x_i (\alpha_i - 1) / z^2 + \sum_{i=1}^k x_i^2 (\alpha_i - 1) / z^3 + \dots + G(z) \\ &= -\frac{2}{z} + \sum_{i=2}^{\infty} \frac{d_i}{z^i} + G(z) \end{aligned} \quad (73)$$

Using the property of the sum of the exterior angles of a polygon, $(1 - \alpha_1)\pi + (1 - \alpha_2)\pi + \dots + (1 - \alpha_k)\pi = 2\pi$. Comparing (73) with (69) we get $G(z)$ identically zero.

Finally integrating equation (72), we find the desired mapping $f(z)$ as

$$f(z) = A \int_{z_0}^z (s - x_1)^{\alpha_1 - 1} (s - x_2)^{\alpha_2 - 1} \dots (s - x_k)^{\alpha_k - 1} ds + B \quad (74)$$

Role of constants A and B

(i) $|A|$ controls the size of the polygon

(ii) $\text{Arg } A$ and B help to select the position, if any, in determining orientation and translation respectively.

An useful observation

In some occasions we urge to make the evaluation process of the integral in (74) simple. For this sake, we consider the point at infinity corresponds to the vertex w_k where the polygon P has an angle $\alpha_k\pi$. Then we can express [see eq. (71)]

$$\frac{d}{dz} \log f^1(z) = \frac{\alpha_k - 1}{z} + \sum_2^{\infty} \frac{\tilde{c}_i}{z^i} \quad (75)$$

in the neighbourhood of the point at infinity.

Again considering the expression of $\frac{d}{dz} \log f^1(z)$ in the neighbourhood of the points corresponding to the vertices w_1, w_2, \dots, w_{k-1} [see eq. (70)].

$$\frac{d}{dz} \log f^1(z) = \frac{\alpha_1 - 1}{z - x_1} + \frac{\alpha_2 - 1}{z - x_2} + \dots + \frac{\alpha_{k-1} - 1}{z - x_{k-1}} + G(z) \quad (75^1)$$

where $G(z)$ is a polynomial. If $|z|$ is large enough, proceeding as earlier

$$\begin{aligned} \frac{d}{dz} \log f^1(z) &= \sum_1^{k-1} (\alpha_i - 1) / z + \sum_1^{k-1} x_i (\alpha_i - 1) / z^2 + \sum_1^{k-1} x_i^2 (\alpha_i - 1) / z^3 + G(z) \\ &= -\frac{\alpha_k + 1}{z} + \sum_2^{\infty} \frac{\tilde{d}_i}{z^i} + G(z) \end{aligned} \quad (76)$$

Comparing (76) with (75), $G(z)$ turns out to be identically zero and hence integrating (75¹) we obtain

$$f(z) = A \int_{z_0}^z (s - x_1)^{\alpha_1 - 1} (s - x_2)^{\alpha_2 - 1} \dots (s - x_{k-1})^{\alpha_{k-1} - 1} ds + B$$

where the role of the constants A and B remain as before.

5.4 Examples : Triangles / Rectangles

The Schwarz-Christoffel transformation is expressed in terms of the points x_j , not in terms of their images i.e., the vertices of the polygon. Not more than three points (x_j) can be chosen arbitrarily. If the point at infinity be one of the x_j 's then only two finite points on the real-axis are free to be chosen, whether the polygon is a triangle or a rectangle etc.

Triangle

Let the polygon be a triangle with vertices w_1, w_2 and w_3 . The S-C transformation is written as

$$w = A \int_{z_0}^z (s - x_1)^{\alpha_1 - 1} (s - x_2)^{\alpha_2 - 1} (s - x_3)^{\alpha_3 - 1} ds + B \quad (77)$$

where $\alpha_1, \pi, \alpha_2\pi$ and $\alpha_3\pi$ are the internal angles at the respective vertices.

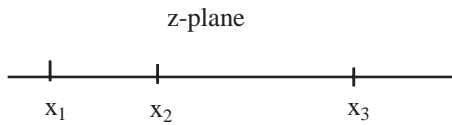

Fig. 58

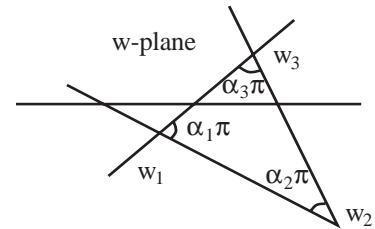

Fig. 59

Here we have chosen all the three finite points x_1, x_2, x_3 on the real-axis.

The constants A, B control the size and position of the triangle respectively.

If we take the vertex w_3 as the image of the point at infinity, the S-C transformation becomes

$$w = A \int_{z_0}^z (s - x_1)^{\alpha_1 - 1} (s - x_2)^{\alpha_2 - 1} ds + B \quad (78)$$

Here x_1 and x_2 can be chosen arbitrarily.

Example 1 : Find a Schwarz-Christoffel transformation that maps the upper half-plane to the inside of the triangle with vertices $-1, 1$ and $\sqrt{3}i$.

Solution :

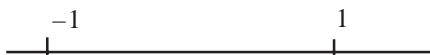

Fig. 60

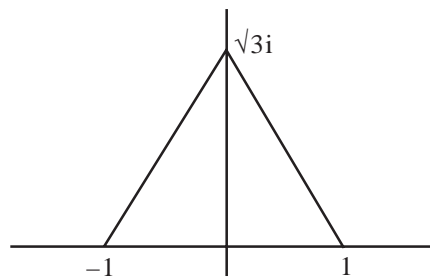

Fig. 61

Following our notation, we write $w_1 = -1, w_2 = 1$ and $w_3 = \sqrt{3}i$ so that $\alpha_1 = \alpha_2 = \alpha_3 = 1/3$. We choose the form (78) of S-C transformation and consider the mapping.

$$f(z) = A \int_0^z (s - x_1)^{-2/3} (s - x_2)^{-2/3} ds + B, \text{ [here } f(\infty) = \sqrt{3}i\text{]}$$

We may choose $x_1 = -1$ and $x_2 = 1$, so that $f(-1) = -1$ and $f(1) = 1$. Therefore

$$\begin{aligned} f(z) &= A \int_0^z (s+1)^{-2/3} (s-1)^{-2/3} ds + B \\ &= A \int_0^z (s^2 - 1)^{-2/3} ds + B \end{aligned}$$

It then follows that

$$= A \int_0^{-1} (s^2 - 1)^{-2/3} ds + B = -1, \quad A \int_0^1 (s^2 - 1)^{-2/3} ds + B = 1.$$

Rewriting these as

$$-AL + B = -1 \text{ and } AL + B = 1, \text{ where } L = \int_0^1 (s^2 - 1)^{-2/3} ds$$

We obtain $A = \frac{1}{\int_0^1 (s^2 - 1)^{-2/3} ds}$ and $B = 0$. Hence

$$f(z) = \frac{1}{\int_0^1 (s^2 - 1)^{-2/3} ds} \int_0^z (s^2 - 1)^{-2/3} ds.$$

Example 2 : Using Schwarz-Christoffel transformation map the upper half-plane onto an equilateral triangle of side 5 units.

Solution :



Fig. 62

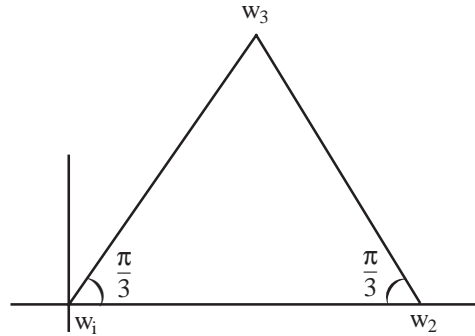

Fig. 63

It is convenient to choose three arbitrary points $x_1 = -1$, $x_2 = 1$ and $x_3 = \infty$ which are mapped into the vertices of the equilateral triangle, so we take S-C transformation (78).

$$f(z) = A \int_1^z (s+1)^{-2/3} (s-1)^{-2/3} ds$$

Here, $f(-1) = w_1 = 0$ and $f(1) = w_2 = 5$. So that

$$A = 5 / \int_{-1}^1 (s^2 - 1)^{-2/3} ds$$

Hence the desired transformation is

$$f(z) = \frac{5 \int_1^z (s^2 - 1)^{2/3} ds}{\int_{-1}^1 (s^2 - 1)^{2/3} ds}$$

Alternative : We take $z_0 = -1$, $A = 1$, $B = 0$ and find S-C transformation as, (choosing one of x_i 's as point at infinity)

$$w = \int_1^z (s+1)(s-1)^{2/3} ds \tag{79}$$

taking $x_1 = -1$ and $x_2 = 1$.

Then $\tilde{f}(1) = \tilde{w}_2$, say, and the image of the point $z = -1$ is the point $\tilde{w}_1 = 0$. When $z = 1$ in the integral we can write $s = x$, where $-1 < x < 1$. Then $x + 1 > 0$ and $\text{Arg}(x+1) = 0$, while $|x-1| = 1-x$ and $\text{Arg}(x-1) = \pi$. Hence

$$\tilde{w}_2 = \int_{-1}^1 (x+1)^{2/3} (1-x)^{2/3} e^{-i2\pi/3} dx$$

$$\begin{aligned}
&= -e^{i\pi/3} \int_{-1}^1 \frac{dx}{(1-x^2)^{2/3}} = -e^{i\pi/3} \int_0^1 \frac{2}{(1-x^2)^{2/3}} dx \\
&= -e^{i\pi/3} \int_0^1 \frac{dt}{\sqrt{t}(1-t)^{2/3}}, \text{ substituting } x = \sqrt{t}. \\
&= -e^{i\pi/3} \mathbf{B}\left(\frac{1}{2}, \frac{1}{3}\right). \text{ We choose } w_2 \text{ as, } w_2 = k\tilde{w}_2 = 5 \text{ where}
\end{aligned}$$

$$k = -5e^{-i\pi/3} / \mathbf{B}\left(\frac{1}{2}, \frac{1}{3}\right).$$

To find w_3 let us first calculate for \tilde{w}_3 .

$$\begin{aligned}
\tilde{w}_3 &= \int_{-1}^{\infty} (x+1)^{-2/3} (x-1)^{-2/3} dx \\
&= \int_{-1}^1 (x+1)^{-2/3} (x-1)^{-2/3} dx + \int_1^{\infty} (x+1)^{-2/3} (x-1)^{-2/3} dx \\
&= -e^{i\pi/3} \mathbf{B}\left(\frac{1}{2}, \frac{1}{3}\right) + e^{-i\pi} \int_{-1}^{\infty} (|x+1||x-1|)^{-2/3} dx \\
&= -e^{-i\pi/3} \mathbf{B}\left(\frac{1}{2}, \frac{1}{3}\right) + e^{-i\pi} \int_{-i}^{\infty} (|x+1||x-1|)^{-2/3} dx \\
&= - + e^{-i\pi+i\frac{2\pi}{3}+i\frac{2\pi}{3}} \int_{-1}^{\infty} |x+1|^{-2/3} e^{-i\frac{2\pi}{3}} |x-1|^{-2/3} e^{-2\pi i/3} dx \\
&= - + e^{1\pi/3} \int_{-1}^{\infty} (x+1)^{-2/3} (x-1)^{-2/3} dx
\end{aligned}$$

Now, the value of \tilde{w}_3 can also be represented by the integral $\int_{-i}^{\infty} (x+1)^{-2/3} (x-1)^{-2/3} dx$ when z tends to infinity along the negative real axis. Thus from the above relation, we have

$$\tilde{w}_3 = -e^{i\pi/3} \mathbf{B}\left(\frac{1}{2}, \frac{1}{3}\right) + e^{i\pi/3} \tilde{w}_3$$

i.e.,
$$\tilde{w}_3 = -e^{i\pi/3} \cdot e^{i\pi/3} \mathbf{B}\left(\frac{1}{2}, \frac{1}{3}\right)$$

So,
$$w_3 = k\tilde{w}_3 = 5e^{\frac{i\pi}{3}}$$

Therefore, the three vertices of the equilateral triangle are $w_1 = 0$, $w_2 = 5$ and $w_3 = 5e^{i\pi/3}$. Clearly each of its sides is of length 5 unit. The desired transformation is then

$$f(z) = K\tilde{f}(z) = \frac{-5e^{-i\pi/3}}{B\left(\frac{1}{2}, \frac{1}{3}\right)} \int_{-1}^z (s+1)^{-2/3}(s-1)^{-2/3} ds$$

which is same as obtained in the first process.

Remark : Following the above technique we can determine a S-C transformation from $\text{Im } z \geq 0$ onto a triangle, in particular, whose one side opposite to an angle is given.

Rectangle :

Example 3 : Find a S-C transformation that maps the upper half of the z -plane to the inside of the rectangle in the w -plane with vertices $-a$, a , $a + ib$ and $-a + ib$ which are the preimages of -1 , 1 , α and $-\alpha$ respectively.

Solution :

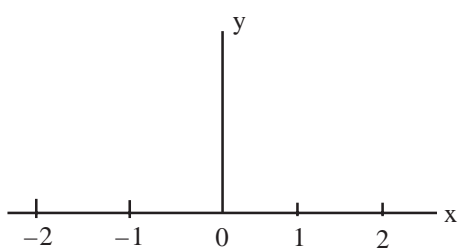

Fig. 64

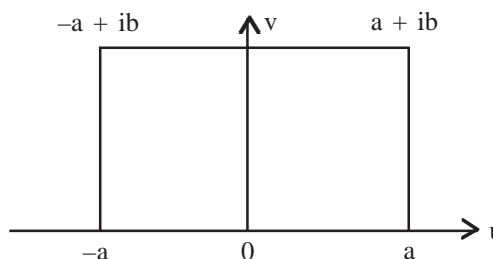

Fig. 65

Let us first make the identification of the vertices of the rectangle

$$w_1 = -a + ib, w_2 = -a, w_3 = a, w_4 = a+ib$$

$$\alpha_1 = \alpha_2 = \alpha_3 = \alpha_4 = 1/2$$

We choose

$$x_1 = -\alpha, x_2 = -1, x_3 = 1, x_4 = \alpha$$

where $\alpha > 1$ will be determined later. We are attempting to benefit from the symmetry here, which requires the image $z = 0$ to be $w = 0$. So taking $z_0 = 0$ we get $B = 0$ in the formula (74) for S-C transformation, which reduces to

$$f(z) = A \int_0^z [s + \alpha)(s + 1)(s - 1)(s - \alpha)]^{-1/2} ds$$

$$= A \int_0^z \frac{ds}{\sqrt{[(1-s^2)(\alpha^2-s^2)]}} (\equiv \phi(z, \alpha)) \quad (80)$$

The constant A may be found by using the fact that $f(1) = a$ i.e.,

$$a = A \int_0^1 \frac{ds}{\sqrt{[(1-s^2)(\alpha^2-s^2)]}} \text{ or } A = a / \int_0^1 \frac{ds}{\sqrt{[(1-s^2)(\alpha^2-s^2)]}} \\ = a/\phi(\alpha), \text{ say} \quad (81)$$

To find α , we apply $f(\alpha) = a + ib$,

$$a + ib = \frac{a}{\phi(\alpha)} \int_0^{\alpha} \frac{ds}{\sqrt{[(1-s^2)(\alpha^2-s^2)]}} \\ = \frac{a}{\phi(\alpha)} \left\{ \int_0^1 \frac{ds}{\sqrt{[(1-s^2)(\alpha^2-s^2)]}} + i \int_1^{\alpha} \frac{ds}{\sqrt{[(s^2-1)(\alpha^2-s^2)]}} \right\}$$

from which, equating imaginary parts, we arrive at

$$b\phi(\alpha) = \alpha \int_1^{\alpha} \frac{ds}{\sqrt{[(s^2-1)(\alpha^2-s^2)]}}$$

Since a and b are known, this equation determines α , which gives rise to the evaluation of $\phi(\alpha)$ i.e. A is completely known.

Note : The function $\phi(z, \alpha)$, given in (80), which involves z as the upper limit of an integral, is called an **elliptic integral of the first kind** and it is not an elementary function. The real definite integral $\phi(\alpha)$ in (81) is called a complete elliptic integral of the first kind.

Example 4 : Find a Schwarz-Christoffel transformation that maps the upper half of the z-plane to the vertical semi-infinite strip $-\pi/2 < u < \pi/2, v > 0$ of the w-plane.

Solution :

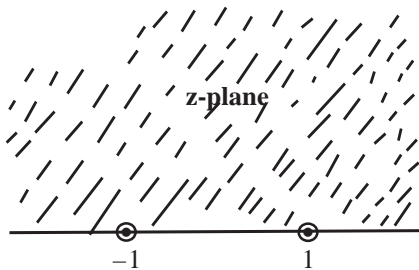

Fig. 66

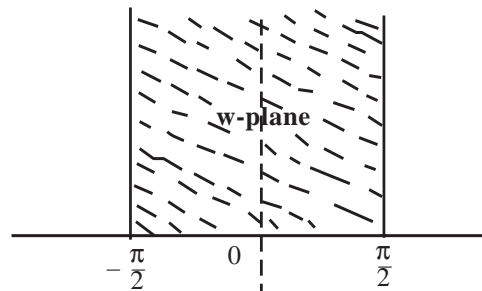

Fig. 67

Here we take $x_1 = -1$, $x_2 = 1$ and $x_3 = \infty$ and the image points are $w_1 = -\pi/2$ and $w_2 = \pi/2$ respectively, so that a S-C transformation can be written as

$$\begin{aligned} f(z) &= A \int_{z_0}^z (s+1)^{-1/2} (s-1)^{-1/2} ds + B \\ &= A \int_{z_0}^z \frac{1}{(s^2-1)^{1/2}} ds + B \\ &= \tilde{A} \log(iz\sqrt{1-z^2}) + \tilde{B} \end{aligned}$$

Using $f(-1) = -\frac{\pi}{2}$ and $f(1) = \frac{\pi}{2}$, we find

$$f(z) = -i \log(iz + \sqrt{1-z^2}),$$

Choosing a suitable branch of the logarithm.

Unit 6 □ Entire and Meromorphic Functions

Structure

- 6.0 Objectives**
- 6.1 Entire function**
- 6.2 Infinite Products**
- 6.3 Infinite product of functions**
- 6.4 Weierstrass Factorization**
- 6.5 Counting zeros of analytic functions**
- 6.6 Convex functions**
- 6.7 Order of an entire function**
- 6.8 The function $n(r)$**
- 6.9 Convergence exponent**
- 6.10 Canonical Product**
- 6.11 Hadamard's Factorization Theorem**
- 6.12 Consequences of Hadamard's Theorem**
- 6.13 Meromorphic functions**
- 6.14 Partial Fraction Expansions of Meromorphic Functions**
- 6.15 Partial Fraction Expansion of Meromorphic functions Using Residue theorem**
- 6.16 The Gamma Function**
- 6.17 A few properties of $\Gamma(z)$**

6.0 The Objectives of the Chapter

In this chapter we shall study entire functions, their growth properties and meromorphic functions. Infinite products and their convergence will be discussed. Properties of zeros of

an entire function, convex functions, gamma function and its important properties will also be discussed.

6.1 Entire function

A function $f(z)$ analytic in the finite complex plane is said to be entire (or sometimes integral) function. Clearly, the sum, difference and product of two or more entire functions are entire functions.

Examples : The polynomial function $P(z) = a_0 + a_1z + \dots + a_nz^n$, exponential function e^z , $\sin z$, $\cos z$ etc. are entire functions.

Let us consider the first example, the polynomial function. It is evident that $P(z)$ can be uniquely expressed as a product of linear factors in the form

$$A_0 \left(1 - \frac{z}{z_1}\right) \left(1 - \frac{z}{z_2}\right) \dots \left(1 - \frac{z}{z_n}\right), \text{ if } a_0 \neq 0$$

or,

$$A_p z^p \left(1 - \frac{z}{\zeta_1}\right) \left(1 - \frac{z}{\zeta_2}\right) \dots \left(1 - \frac{z}{\zeta_{n-p}}\right), \text{ if } a_0 = a_1 = \dots = a_{p-1} = 0, a_p \neq 0, \quad (82)$$

where A_0 (or, A_p) is constant and $z = z_1, z_2, \dots, z_n$ (or, $z = 0, \zeta_1, \zeta_2, \dots, \zeta_{n-p}$) are the zeros of $P(z)$, multiple zeros are counted according to their multiplicities. There arises a natural question : whether any entire function can be expressed in a similar manner in terms of its zeros. The observations are as follows :

(i) There may exist entire function which never vanishes,

(ii) If an entire function possesses finite number of zeros, then it is always possible to express it in the form (82) stated above. But when the number of zeros are infinite the form (82) reduces to a product of infinite number of linear factors which need not always be convergent. We first consider infinite products of complex numbers and functions.

6.2 Infinite Products

An infinite product is an expression of the form

$$\prod_{n=1}^{\infty} p_n \quad (83)$$

where $p_1, p_2, \dots, p_n, \dots$ are non-zero complex factors. If we allow any of the factors be zero, it is evident that the infinite product would be zero regardless of the behaviour of the other terms.

Let $P_n = p_1 p_2 \dots p_n$.

If P_n tends to a finite limit (non-zero) p as n tends to infinity, we say that the infinite product (83) is convergent and write as

$$\prod_{n=1}^{\infty} p_n = p \quad (84)$$

An infinite product which does not tend to a non-zero finite limit as n tends to infinity is said to be divergent.

To find the necessary condition for convergence for the infinite product $\prod_{n=1}^{\infty} p_n$, say (84) holds, then writing p_n as

$$p_n = \frac{P_n}{P_{n-1}}$$

we conclude in view of (84) that $\lim_{n \rightarrow \infty} p_n = \lim_{n \rightarrow \infty} \frac{P_n}{P_{n-1}} = \frac{P}{P} = 1$

Thus, $\lim_{n \rightarrow \infty} p_n = 1$ (85)

is a necessary condition for convergence of the infinite product (83). It is then better to write the product as

$$\prod_{n=1}^{\infty} (1 + a_n) \quad (86)$$

so that $a_n \rightarrow 0$ as $n \rightarrow \infty$ is a necessary condition for convergence.

Theorem 6.1 : The infinite product (86) converges if and only if

$$\sum_{n=1}^{\infty} \log(1 + a_n) \quad (87)$$

converges. We use the principal branch of the log function and omit, as usual, the terms with $a_n = -1$.

Proof. Let $P_n = \prod_{k=1}^n (1 + a_k)$ and $S_n = \sum_{k=1}^n \log(1 + a_k)$.

Then $\log P_n = S_n$ and $P_n = e^{S_n}$. Now if the given series is convergent i.e. $S_n \rightarrow S$ as $n \rightarrow \infty$, P_n tends to the limit $P = e^S (\neq 0)$. This proves the sufficiency of the condition.

Conversely, assume that the product converges i.e. $P_n \rightarrow P (\neq 0)$ as $n \rightarrow \infty$. We shall show, by virtue of $P_n = e^{S_n}$, that the series (87) converges to some value of $\log P$, not necessarily the principal value of $\log P$.

For $n \rightarrow \infty$, $\frac{P_n}{P} \rightarrow 1$ and $\text{Log}\left(\frac{P_n}{P}\right) \rightarrow 0$.

Now there exists an integer K_n such that

$$\text{Log}\left(\frac{P_n}{P}\right) = S_n - \text{Log} P + 2k_n \pi i \quad (88)$$

To establish the convergence of the sequence $\{k_n\}$, we form the difference

$$\begin{aligned} (k_{n+1} - k_n)2\pi i &= \text{Log}\left(\frac{P_{n+1}}{P}\right) - \text{Log}\left(\frac{P_n}{P}\right) - \text{Log}(1 + a_{n+1}) \\ &= i \left\{ \text{Arg}\left(\frac{P_{n+1}}{P}\right) - \text{Arg}\left(\frac{P_n}{P}\right) - \text{Arg}(1 + a_{n+1}) \right\} \end{aligned}$$

and that

$$k_{n+1} - k_n = \frac{1}{2\pi} \left\{ \text{Arg}\left(\frac{P_{n+1}}{P}\right) - \text{Arg}\left(\frac{P_n}{P}\right) - \text{Arg}(1 + a_{n+1}) \right\}$$

tends to zero as $n \rightarrow \infty$, and let the limit of the sequence $\{k_n\}$ be k .

Taking limit in (88), we find that

$$S_n \rightarrow \text{Log} P - 2k\pi i$$

and so the condition assumed is necessary.

Definition : An infinite product $\prod_{n=1}^{\infty} (1 + a_n)$ is absolutely convergent if and only if $\sum_{n=1}^{\infty} |\log(1 + a_n)|$ is convergent.

Theorem 6.2 : The infinite product (86) converges absolutely if and only if the series $\sum a_n$ converges absolutely.

Proof : If $\sum a_n$ converges absolutely, then in particular $a_n \rightarrow 0$ as $n \rightarrow \infty$. Also, if $\sum_{n=1}^{\infty} \log(1 + a_n)$ converges absolutely then $\log(1 + a_n) \rightarrow 0$ and $a_n \rightarrow 0$. Thus in

either of the cases $a_n \rightarrow 0$ and we can take $|a_n| \leq \frac{1}{2}$ for sufficiently large n . Then by elementary calculation,

$$\left| 1 - \frac{\log(1 + a_n)}{a_n} \right| = \left| \frac{a_n}{2} - \frac{a_n^2}{3} + \dots \right|$$

$$\leq \frac{1}{2} \left\{ |a_n| + |a_n|^2 + |a_n|^3 + \dots \right\} \leq \frac{1}{2}, \quad n = \text{large enough. It follows that}$$

$$\frac{1}{2}|a_n| \leq \log|1 + a_n| \leq \frac{3}{2}|a_n|$$

confirming the occurrence of the absolute convergence simultaneously for the two series.

6.3 Infinite product of functions

So far we have considered infinite product of complex numbers. Now we shall study infinite products whose factors are functions of a complex variable. Some of the factors (finite in number) may vanish on a region considered. In that case we consider the infinite product omitting those factors. The theorems proved earlier hold good in this case too with some modifications.

Definition : (Uniform convergence of infinite products)

An infinite product

$$\prod_{n=1}^{\infty} \{1 + a_n(z)\} \tag{89}$$

where the functions $a_n(z)$ are defined on a region D , is said to be uniformly convergent on D if the sequence of partial products

$$P_n(z) = \prod_{k=1}^n \{1 + a_k(z)\}$$

converges uniformly to a non-zero limit on D .

Theorem 6.3 : An infinite product (89) is uniformly convergent on a domain D if the series $\sum_{n=1}^{\infty} |a_n(z)|$ converges uniformly and has a bounded sum there.

Proof : Let M be the upper bound of the sum $\sum |a_n(z)|$ on D . Then

$$\{1 + a_1(z)\} \{1 + |a_2(z)|\} \dots \{1 + |a_n(z)|\} < e^{|a_1(z)| + |a_2(z)| + \dots + |a_n(z)|} \leq e^M$$

Let us consider the sequence $\{Q_n\}$ with

$$Q_n(z) = \prod_{k=1}^n \{1 + |a_k(z)|\}$$

We observe

$$\begin{aligned} Q_n(z) - Q_{n-1}(z) &= \{1 + |a_1(z)|\}\{1 + |a_2(z)|\}\dots\{1 + |a_{n-1}(z)|\}|a_n(z)| \\ &< e^M |a_n(z)| \end{aligned}$$

Now since the series $\sum |a_n(z)|$ is uniformly convergent, the series $\sum \{Q_n(z) - Q_{n-1}(z)\}$ is uniformly convergent. Thus the sequence $\{Q_n\}$ tends to a limit. Again

$$|P_n(z) - P_{n-1}(z)| \leq Q_n(z) - Q_{n-1}(z),$$

so the result follows.

Theorem 6.4 : An infinite product $\prod_{n=1}^{\infty} \{1 + a_n(z)\}$ converges uniformly and absolutely in a closed bounded domain D if each function $a_n(z)$ satisfies $|a_n(z)| \leq M_n$ for all $z \in D$ and M_n is independent of z and moreover $\sum M_n$ is convergent.

Proof : Given $\sum M_n$ is convergent, so the infinite product $M = \prod_{n=1}^{\infty} (1 + M_n)$ converges by theorem 6.2

Now, for $n > m$

$$|Q_n(z) - Q_m(z)| = |Q_m(z)| \left| \prod_{k=m+1}^n \{1 + a_k(z)\} - 1 \right| \quad (90)$$

Again,

$$\begin{aligned} \prod_{m+1}^n \{1 + a_k(z)\} - 1 &= \sum_{k=m+1}^n a_k(z) + \sum_{i,j}^n a_i(z)a_j(z) + \sum_{i,j,l}^n a_i(z)a_j(z)a_l(z) \\ &+ \dots + a_{m+1}(z)a_{m+2}(z)\dots a_n(z). \end{aligned}$$

Taking moduli

$$\begin{aligned} \left| \prod_{m+1}^n \{1 + a_k(z)\} - 1 \right| &\leq \sum_{k=m+1}^n M_k + \sum_{i,j}^n M_i M_j + \sum_{i,j,l}^n M_i M_j M_l + \\ &+ \dots + M_{m+1} M_{m+2} \dots M_n \\ &= \prod_{m+1}^n (1 + M_k) - 1 \end{aligned}$$

Utilising this in (90) we obtain

$$\begin{aligned}
|Q_n(z) - Q_m(z)| &\leq \prod_{k=1}^m (1 + M_k) \left\{ \prod_{m=1}^n (1 + M_k) - 1 \right\} \\
&= \prod_{k=1}^n (1 + M_k) - \prod_{k=1}^m (1 + M_k) \tag{91}
\end{aligned}$$

Now as the infinite product $\prod_1^\infty (1 + M_k)$ is convergent, we choose m large enough so that r.h.s in (91) is less than ε and hence

$$|Q_n(z) - Q_m(z)| < \varepsilon, \text{ when } n > m$$

Thus the sequence $\{Q_n(z)\}$ converge uniformly, since m depends only on ε .

Finally, absolute convergence of the infinite product follows on utilising Th. 6.2

Example 1 : Test for convergence of the infinite product

$$\prod_{n=1}^{\infty} \left(1 - \frac{z^2}{n^2} \right)$$

Solution : The terms of the product vanish when $z = \pm 1, \pm 2, \dots$ etc.

$$\text{Here } a_n(z) = -\frac{z^2}{n^2} \text{ and } |a_n(z)| \leq |z|^2 \frac{1}{n^2}$$

Now since the series $\sum \frac{1}{n^2}$ is convergent, the given infinite product is uniformly and absolutely convergent in the entire plane excluding the points $z = \pm 1, \pm 2, \dots$ etc.

Example 2 : Discuss the convergence of the infinite product

$$\left(1 - \frac{z}{1} \right) \left(1 + \frac{z}{1} \right) \left(1 - \frac{z}{2} \right) \left(1 + \frac{z}{2} \right) \dots$$

Solution : Let $P_n(z) = \prod_{k=1}^n \left(1 - \frac{z^2}{k^2} \right)$ and we consider a bounded closed domain D

which does not contain the points $z = \pm 1, \pm 2, \dots$. The sequence $\{P_n(z)\}$ converges uniformly in D (see example 1). Again let

$$F_{2n}(z) = \left(1 - \frac{z}{1} \right) \left(1 + \frac{z}{1} \right) \left(1 - \frac{z}{2} \right) \left(1 + \frac{z}{2} \right) \dots \left(1 - \frac{z}{n} \right) \left(1 + \frac{z}{n} \right)$$

$$F_{2n+1}(z) = F_{2n}(z) \left(1 - \frac{z}{n+1} \right),$$

then $F_{2n}(z) = P_n(z)$ and $F_{2n+1}(z) = \left(1 - \frac{z}{n+1} \right) P_n(z)$

and obviously the sequences F_2, F_4, F_6, \dots and $F_1, F_3, F_5 \dots$ converge uniformly in D . Hence the given infinite product converges uniformly in D .

To test for the absolute convergence of the given product we notice that

$$\sum_i |a_n| = |z| \left\{ 1 + 1 + \frac{1}{2} + \frac{1}{2} + \frac{1}{3} + \frac{1}{3} + \dots \right\}$$

and it is divergent since the series on the right is divergent and $|z|$ is finite. Therefore the given product does not converge absolutely.

Considering the theorem 4.4 on uniformly convergent sequence of analytic functions [(14) Page-72] we get the following theorem :

Theorem 6.5 : If an infinite product $\prod \{1 + f_n(z)\}$ converges uniformly to $f(z)$ in a bounded closed domain D and if each function $f_n(z)$ is analytic in D , then $f(z)$ is also analytic in D .

6.4 Weierstrass' Factorization

Theorem 6.6 : If $f(z)$ is an entire function and never vanishes on \mathcal{C} , then $f(z)$ is of the form $f(z) = e^{g(z)}$, or, more generally, $f(z) = ce^{g(z)}$, $c \neq 0$, constant.

where $g(z)$ is also an entire function.

Proof : Since f is entire and never vanishes on \mathcal{C} , $f^{1/f}$ is also entire and is thus the derivative of an entire function $g(z)$. [follows from Result 1, PG(MT) 02-complex analysis [14, page-54]. Then

$$\frac{f'}{f} = g'$$

i.e. $f' = fg'$

Now, $(fe^{-g})' = f'e^{-g} - fg'e^{-g} = 0$

Hence, $f(z) = ce^{g(z)}$ proving the result.

Assume now that f possesses finitely many zeros, a zero of order $m > 0$ at the origin, and the non-zero ones, possibly repeated are a_1, \dots, a_n . Then

$$f(z) = z^m \prod_{k=1}^n \left(1 - \frac{z}{a_k}\right) e^{g(z)}$$

where g is entire.

This is clear, since if we divide f by the factors which produce zero at the points $z = 0, a_1, \dots, a_n$ we get an entire function with no zeros.

However we cannot expect, in general, such a simple formula to hold in the case of infinitely many zeros. Here we have to take care of convergence problems for an infinite product. In fact the obvious generalization.

$$f(z) = z^m \prod_{k=1}^n \left(1 - \frac{z}{a_k}\right) e^{g(z)}$$

is valid in a bounded closed domain D if the infinite product converges uniformly in D .

Theorem 6.7 (Weierstrass' Factorization Theorem) :—

Let $\{a_n\}$ be a sequence of complex numbers with the property $a_n \rightarrow \infty$ as $n \rightarrow \infty$. Then it is possible to construct an entire function $f(z)$ with zeros precisely at these points.

Proof : We need Weierstrass' primary factors to construct the desired function.

The expressions $E(z, 0) = 1 - z$, $E(z, p) = (1 - z)e^{z + \frac{z^2}{2} + \dots + \frac{z^p}{p}}$, $p = 1, 2, \dots$, are called Weierstrass' primary factors. Each primary factor is an entire function having only one simple zero at $z = 1$.

$$\begin{aligned} \text{Now, when } |z| < 1 \text{ we have, } \log E(z, p) &= \log(1-z) + z + \frac{z^2}{2} + \dots + \frac{z^p}{p} \\ &= \left(-z - \frac{z^2}{2} - \dots - \frac{z^p}{p} - \frac{z^{p+1}}{p+1} - \dots\right) + \left(z + \frac{z^2}{2} + \dots + \frac{z^p}{p}\right) = -\frac{z^{p+1}}{p+1} - \frac{z^{p+2}}{p+2} - \dots \end{aligned}$$

Here we have taken the principal branch of $\log(1 - z)$.

Hence if

$$\begin{aligned} |z| \leq \frac{1}{2}, \quad |\log E(z, p)| &\leq |z|^{p+1} + |z|^{p+2} + \dots = |z|^{p+1} (1 + |z| + |z|^2 + \dots) \\ &\leq |z|^{p+1} \left(1 + \frac{1}{2} + \frac{1}{2^2} + \dots\right) = 2|z|^{p+1} \dots \end{aligned} \tag{92}$$

We may suppose that the origin is not a zero of the entire function $f(z)$ to be constructed so that $a_n \neq 0$ for all n .

For, if origin is a zero of $f(z)$ of order m we need only multiply the constructed function by z^m . We also arrange the zeros in order of non-decreasing modulus (if several distinct points a_n have the same modulus, we take them in any order) so that $|a_1| \leq |a_2| \leq \dots$. Let $|a_n| = r_n$.

Since $r_n \rightarrow \infty$ we can always find a sequence of positive integers

$m_1, m_2, \dots, m_n, \dots$ such that the series $\sum_{n=1}^{\infty} \left(\frac{r}{r_n}\right)^{m_n}$ converges for all positive values of r .

In fact, we may take $m_n = n$ since for any given value of r , we have $\left(\frac{r}{r_n}\right)^n < \frac{1}{2^n}$ for all sufficiently large n and the series is therefore convergent. Next we take an arbitrary positive number R and choose the integer N such that $r_N \leq 2R < r_{N+1}$. Hence, when $|z| \leq R$ and $n > N$ we have,

$$\left|\frac{z}{a_n}\right| \leq \frac{R}{r_n} \leq \frac{R}{r_{N+1}} < \frac{1}{2} \text{ and so by (92),}$$

$$\left|\log E\left(\frac{z}{a_n}, m_n\right)\right| \leq 2\left|\frac{R}{r_n}\right|^{m_n+1} \text{ By Weierstrass' M-test the series } \sum_{n=1}^{\infty} \log E\left(\frac{z}{a_n}, m_n\right)$$

converges absolutely and uniformly when $|z| \leq R$ and so the infinite product $\prod_{n=1}^{\infty} E\left(\frac{z}{a_n}, m_n\right)$ converges absolutely and uniformly in the disc $|z| \leq R$, however large R may be. Hence the above product represents an entire function, say $G(z)$.

$$\text{Thus, } G(z) = \prod_{n=1}^{\infty} E\left(\frac{z}{a_n}, m_n\right) \quad (93)$$

With the same value of R , we choose another integer k such that $r_k \leq R < r_{k+1}$.

Then each of the functions of the sequence $\prod_{n=1}^m E\left(\frac{z}{a_n}, m_n\right)$, $m = k+1, k+2, \dots$,

vanish at the points a_1, \dots, a_k and nowhere else in $|z| \leq R$. Hence by Hurwitz's theorem the only zeros of G in $|z| \leq R$ are a_1, \dots, a_k . Since R is arbitrary, this implies that the only zeros of G are the points of the sequence $\{a_n\}$.

Now, if origin is a zero of order m of the required entire function $f(z)$, then $f(z)$ is of the form $f(z) = z^m G(z)$. Again, for any entire function $g(z)$, $e^{g(z)}$ is also an entire function without any zero. Hence the general form of the required entire function $f(z)$ is

$$\begin{aligned} f(z) &= z^m e^{g(z)} G(z) \\ &= z^m e^{g(z)} \prod_{n=1}^{\infty} E\left(\frac{z}{a_n}, m_n\right) \end{aligned} \quad (94)$$

$$= z^m e^{g(z)} \prod_{n=1}^{\infty} \left(1 - \frac{z}{a_n}\right) e^{\frac{z}{a_n} + \frac{1}{2}\left(\frac{z}{a_n}\right)^2 + \dots + \frac{1}{m_n}\left(\frac{z}{a_n}\right)^{m_n}} \quad (95)$$

Remark : As there are many possible sequences $\{m_n\}$ in the construction of the function $G(z)$ and ultimately of $f(z)$, the form of the function $f(z)$ achieved is not unique.

6.5 Counting zeros of analytic functions

The rate of growth of an entire function is closely related to the density of zeros. We have a quite effective formula in this regard due to J.L.W.V. Jensen, a Danish mathematician who discovered it in the year 1899.

Theorem 6.8 [Jensen's Formula] :—

Let $f(z)$ be analytic on $|z| \leq R$, $f(0) \neq 0$ and $f(z) \neq 0$ on $|z| = R$. If a_1, \dots, a_n be the zeros of $f(z)$ within the circle $|z| = R$, multiple zeros being repeated according to their multiplicities, then

$$\log|f(0)| = \frac{1}{2\pi} \int_0^{2\pi} \log|f(Re^{i\theta})| d\theta - \sum_{k=1}^n \log\left(\frac{R}{|a_k|}\right) \dots \quad (96)$$

Proof : Let $\phi(z) = f(z) \cdot \prod_{k=1}^n \frac{R^2 - \bar{a}_k z}{R(z - a_k)} \dots$ (97)

The zeros of the denominator of $\phi(z)$ are also the zeros of $f(z)$ of the same order. Hence the zeros of $f(z)$ cancels the poles a_n in the product and so $\phi(z)$ is analytic on $|z| \leq R$. Also, $\phi(z) \neq 0$ on $|z| \leq R$. For, if $R^2 - \bar{a}_k z = 0$ then $z = \frac{R^2}{\bar{a}_k}$ is the inverse point of a_k with respect to the circle $|z| = R$ and so lies outside the circle. Again,

$$|\phi(z)| = |f(z)| \left| \frac{R^2 - \bar{a}_1 z}{R(z - a_1)} \right| \dots \left| \frac{R^2 - \bar{a}_n z}{R(z - a_n)} \right|. \text{ Now, when } |z| = R$$

$$\text{we have, } \left| \frac{R^2 - \bar{a}_k z}{R(z - a_k)} \right| = \left| \frac{z\bar{z} - \bar{a}_k z}{R(z - a_k)} \right| = \frac{|z|}{R} \left| \frac{\bar{z} - \bar{a}_k}{z - a_k} \right| = 1$$

Hence, $|\phi(z)| = |f(z)|$ on $|z| = R$.

Since $\phi(z)$ is analytic and non-zero on $|z| \leq R$, $\log \phi(z)$ is also analytic on $|z| \leq R$ and consequently $\text{Re } \log \phi(z) = \log |\phi(z)|$ is harmonic on $|z| \leq R$. Hence by Gauss' mean value theorem,

$$\log|\phi(0)| = \frac{1}{2\pi} \int_0^{2\pi} \log|\phi(Re^{i\theta})| d\theta \quad (98)$$

From (97) we have, $|\phi(0)| = |f(0)| \frac{R}{|a_1|} \cdot \frac{R}{|a_2|} \cdots \frac{R}{|a_n|}$.

Hence from (98) we get,

$$\log|f(0)| + \sum_{k=1}^n \log\left(\frac{R}{|a_k|}\right) = \frac{1}{2\pi} \int_0^{2\pi} \log|\phi(\text{Re}^{i\theta})| d\theta$$

$$\text{i.e. } \log|f(0)| = \frac{1}{2\pi} \int_0^{2\pi} \log|f(\text{Re}^{i\theta})| d\theta - \sum_{k=1}^n \log\left(\frac{R}{|a_k|}\right)$$

(since $|\phi(z)| = |f(z)|$ on $|z| = R$)

Note : We observe that Jensen's formula can also be expressed as

$$\log \frac{R^n}{|a_1 \dots a_n|} = \frac{1}{2\pi} \int_0^{2\pi} \log|f(\text{Re}^{i\theta})| d\theta - \log|f(0)| \dots \dots \quad (99)$$

$$\text{or as, } \log \frac{R^n}{r_1 \dots r_n} = \frac{1}{2\pi} \int_0^{2\pi} \log|f(\text{Re}^{i\theta})| d\theta - \log|f(0)| \dots \dots \quad (100)$$

where $|a_i| = r_i, i = 1, \dots, n$.

Theorem 6.9 (Jensen's inequality) :— Let $f(z)$ be analytic on $|z| \leq R, f(0) \neq 0$ and $f(z) \neq 0$ on $|z| = R$. If a_1, \dots, a_n be the zeros of $f(z)$ within $|z| = R$, multiple zeros being repeated according to their multiplicities, and $|a_i| = r_i, i = 1, \dots, n$, then

$$\frac{R^n |f(0)|}{r_1 \dots r_n} \leq M(R) \quad (101)$$

where $M(R) = \max_{|z|=R} |f(z)|$.

Proof : As in Jensen's formula (theorem 6.8) we have, $|\phi(z)| = |f(z)|$ on $|z| = R$ and so by the maximum modulus theorem, $|\phi(z)| \leq M(R)$ for $|z| \leq R$. In particular,

$$|\phi(0)| \leq M(R)$$

$$\text{i.e. } \frac{R^n |f(0)|}{r_1 \dots r_n} \leq M(R).$$

Theorem 6.10 (Poisson-Jensen formula) :- Let $f(z)$ be analytic on $|z| \leq R, f(0) \neq 0$ and $f(z) \neq 0$ on $|z| = R$. If $a_1 \dots a_n$ be the zeros of $f(z)$ within the circle $|z| = R$, multiple zeros being repeated according to their multiplicities, then for any $z = re^{i\theta}, r < R$,

$$\log|f(re^{i\theta})| = \frac{1}{2\pi} \int_0^{2\pi} \frac{R^2 - r^2}{R^2 + r^2 - 2Rr \cos(t - \theta)} \log|f(\text{Re}^{it})| dt - \sum_{k=1}^n \log \left| \frac{R^2 - \bar{a}_k re^{i\theta}}{R(re^{i\theta} - a_k)} \right|.$$

Proof : Let $\phi(z) = f(z) \cdot \prod_{k=1}^n \frac{R^2 - \bar{a}_k z}{R(z - a_k)}$. Then, as in Jensen's formula we have, $|\phi(z)| = |f(z)|$ on $|z| = R$. Since $\phi(z)$ is analytic and non-zero on $|z| \leq R$, $\log \phi(z)$ is also analytic on $|z| \leq R$ and consequently $\log |\phi(z)|$ is harmonic on $|z| \leq R$.

So, by Poisson's integral formula,

$$\log |\phi(re^{i\theta})| = \frac{1}{2\pi} \int_0^{2\pi} \frac{R^2 - r^2}{R^2 + r^2 - 2Rr \cos(t - \theta)} \log |\phi(Re^{it})| dt \quad (102)$$

$$\text{Now, } \log |\phi(re^{i\theta})| = \log |f(re^{i\theta})| + \sum_{k=1}^n \log \left| \frac{R^2 - \bar{a}_k re^{i\theta}}{R(re^{i\theta} - a_k)} \right|$$

Since $\log |\phi(z)| = \log |f(z)|$ on $|z| = R$ we get from (102)

$$\begin{aligned} \log |f(re^{i\theta})| &= \frac{1}{2\pi} \int_0^{2\pi} \frac{R^2 - r^2}{R^2 + r^2 - 2Rr \cos(t - \theta)} \cdot \log |f(Re^{it})| dt \\ &\quad - \sum_{k=1}^n \log \left| \frac{R^2 - \bar{a}_k re^{i\theta}}{R(re^{i\theta} - a_k)} \right| \end{aligned} \quad (103)$$

6.6 Convex functions

The property of convexity plays an important role in function theory because in several cases some lead factors associated with entire, meromorphic and subharmonic functions appear to be convex functions.

A real-valued function ϕ defined on the interval $I = [a, b]$ is said to be convex if for any two points s, u in $[a, b]$

$$\phi(\lambda u + (1 - \lambda)s) \leq \lambda \phi(u) + (1 - \lambda) \phi(s) \text{ for } 0 \leq \lambda \leq 1 \quad (104)$$

Geometrically, the condition (104) is equivalent to the condition that if $s < x < u$, then the point $(x, \phi(x))$ should lie below or on the chord joining the points $(s, \phi(s))$ and $(u, \phi(u))$ in the plane.

Analytical condition for $\phi(x)$ to be convex in $[a, b]$:- Let the coordinates of the points A, B, C on the curve $y = \phi(x)$ as shown in the adjoining figure be $(s, \phi(s))$, $(u, \phi(u))$ and $(x, \phi(x))$ respectively where $s < x < u$.

Equation of the chord AB is $y - \phi(x) = \frac{\phi(u) - \phi(s)}{u - s}(x - s)$.

$$\text{or, } y = \phi(s) + \frac{\phi(u) - \phi(s)}{u - s}(x - s) \quad (105)$$

Let the coordinates of any point D on the chord AB be (x, y) . According to definition $\phi(x)$ will be convex if and only if $CN \leq DN$. i.e., if and only if $\phi(x) \leq y$; i.e. if and only if

$$\phi(x) \leq \phi(s) + \frac{\phi(u) - \phi(s)}{u - s}(x - s); \text{ i.e., if and only if}$$

$$\phi(x) \leq \frac{u - x}{u - s} \phi(s) + \frac{x - s}{u - s} \phi(u) \quad (106)$$

for $s < x < u$.

We now state two results on convex functions without proof.

Result 1. A differentiable function $f(x)$ on $[a, b]$ is convex if and only if $f'(x)$ is increasing in $[a, b]$.

Result 2. A sufficient condition for $f(x)$ to be convex is that $f''(x) > 0$.

The maximum modulus function : Let $f(z)$ be a non-constant analytic function in $|z| < R$. Then for $0 \leq r < R$ we define the maximum modulus function $M(r, f)$ or, simply $M(r)$ by $M(r) = \max_{|z|=r} |f(z)|$. By maximum modulus theorem we can also write $M(r) = \max_{|z|=r} |f(z)|$.

Result : Let $f(z)$ be a non-constant analytic function in $|z| < R$. Then $M(r)$ is a strictly increasing function of r in $0 \leq r \leq R$.

Proof : Let $0 \leq r_1 < r_2 < R$. Since $f(z)$ is analytic in $|z| \leq r_2$, the maximum value of $|f(z)|$ for $|z| \leq r_2$ is attained on $|z| = r_2$. Let z_2 be a point on $|z| = r_2$ such that $|f(z_2)| = M(r_2)$. Similarly, the maximum value of $|f(z)|$ for $|z| \leq r_1$ is attained on $|z| = r_1$. Let z_1 be a point on $|z| = r_1$ such that $|f(z_1)| = M(r_1)$.

Since $r_1 < r_2$, z_1 is an interior point of the closed region $|z| \leq r_2$. Hence by maximum modulus theorem,

$$|f(z_1)| < M(r_2); \text{ i.e. } M(r_1) < M(r_2).$$

This proves the result.

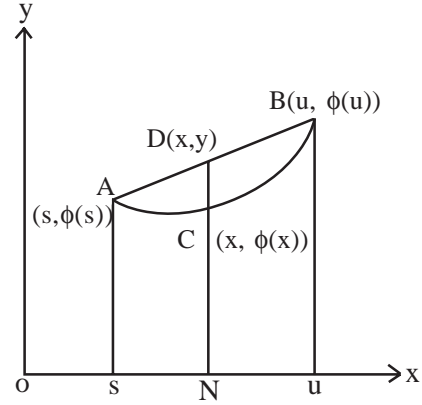

Corollary : Let $f(z)$ be a non-constant entire function. Then its maximum modulus function $M(r) \rightarrow \infty$ as $|z| = r \rightarrow \infty$. For, if $M(r)$ is bounded, then by Liouville's theorem $f(z)$ would be a constant function.

Theorem 6.11 [Hadamard's three-circles theorem].

Let $0 < r_1 < r < r_3$ and suppose that $f(z)$ is analytic on the closed annulus $r_1 \leq |z| \leq r_3$. If $M(r) = \max_{|z|=r} |f(z)|$, then

$$M(r)^{\log\left(\frac{r_3}{r_1}\right)} \leq M(r_1)^{\log\left(\frac{r_3}{r}\right)} \cdot M(r_3)^{\log\left(\frac{r}{r_1}\right)} \quad (107)$$

Proof : Let us consider the function $\phi(z) = z^\alpha f(z)$, where α is a real constant to be chosen later. If $\alpha \neq$ an integer, $\phi(z)$ is multi-valued in $r_1 \leq |z| \leq r_3$ and so we cut the annulus along the negative part of the real axis. Thus we obtain a simply connected region G in which the principal branch of $\phi(z)$ is analytic. Hence the maximum modulus of this branch of $\phi(z)$ in G is attained on the boundary of G . Since α is real, all the branches of $\phi(z)$ have the same modulus. If we consider another branch of $\phi(z)$ which is analytic in another cut annulus it is clear that the principal branch of $\phi(z)$ can not attain its maximum value on the cut. Hence maximum of $|\phi(z)|$ is attained on at least one of the bounding circles $|z| = r_1$ or, $|z| = r_3$. Thus,

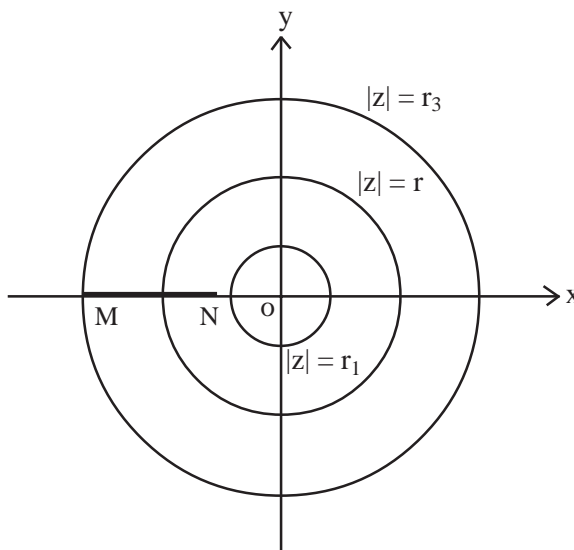

$$\begin{aligned} |z^\alpha f(z)| &\leq \max(r_1^\alpha M(r_1), r_3^\alpha M(r_3)). \text{ Hence on } |z| = r, \\ r^\alpha M(r) &\leq \max(r_1^\alpha M(r_1), r_3^\alpha M(r_3)) \end{aligned} \quad (108)$$

We now choose α such that $r_1^\alpha M(r_1) = r_3^\alpha M(r_3)$. Then

$$\alpha = -\frac{\log(M(r_3)/M(r_1))}{\log(r_3/r_1)}. \text{ Substituting this value of } \alpha \text{ in (108) we get,}$$

$$\begin{aligned} M(r) &\leq \left(\frac{r}{r_1}\right)^{-\alpha} M(r_1) \\ &= \left(\frac{r}{r_1}\right)^{\log\left(\frac{M(r_3)}{M(r_1)}\right)} / \log\left(\frac{r_3}{r_1}\right) \cdot M(r_1) \end{aligned}$$

and so
$$M(r)^{\log(r_3/r_1)} \leq \left(\frac{r}{r_1}\right)^{\log(M(r_3)/M(r_1))} \cdot M(r_1)^{\log(r_3/r_1)}$$

That is,
$$M(r)^{\log(r_3/r_1)} \leq \left(\frac{M(r_3)}{M(r_1)}\right)^{\log(r/r_1)} \cdot M(r_1)^{\log(r_3/r_1)} \quad [\text{since } a^{\log b} = b^{\log a}]$$

$$= M(r_1)^{\log(r_3/r)} \cdot M(r_3)^{\log(r/r_1)}.$$

Note : Equality in (107) occurs when $\phi(z)$ is a constant, i.e. when $f(z)$ is of the form cz^α for some real α and c is a constant.

Corollary : $\log M(r)$ is a convex function of $\log r$.

Proof : Let $f(z)$ be analytic in the closed annulus $0 < r_1 \leq |z| \leq r_2$.

If $r_1 < r < r_2$ we have, by Hadamard's three-circles theorem,

$$M(r)^{\log(r_2/r_1)} \leq M(r_1)^{\log(r_2/r)} \cdot M(r_2)^{\log(r/r_1)}.$$

Taking logarithms we get $(\log r_2 - \log r_1) \log M(r) \leq (\log r_2 - \log r) \log M(r_1) +$

$(\log r - \log r_1) \log M(r_2)$. That is,

$$\log M(r) \leq \frac{\log r_2 - \log r}{\log r_2 - \log r_1} \log M(r_1) + \frac{\log r - \log r_1}{\log r_2 - \log r_1} \log M(r_2) \quad (109)$$

The inequality (109) shows that $\log M(r)$ is a convex function of $\log r$.

6.7 Order of an entire function

An entire function $f(z)$ is said to be of finite order if there is a positive number A such that as $|z| = r \rightarrow \infty$, the inequality $M(r) < e^{r^A}$ holds.

The lower bound ρ of such numbers A is called the order of the function.

f is said to be of infinite order if it is not of finite order. From the definition it is clear that order of an entire function is non-negative.

Result : Let f be an entire function of order ρ and $M(r) = \max\{|f(z)| : |z| = r\}$. Then

$$\rho = \limsup_{r \rightarrow \infty} \frac{\log \log M(r)}{\log r} \quad (110)$$

Proof : By hypothesis, given $\varepsilon > 0$ there exists $r_0(\varepsilon) > 0$ such that

$$M(r) < e^{r^{\rho+\varepsilon}} \text{ for } r > r_0$$

while $M(r) > e^{r^{\rho-\varepsilon}}$ for an increasing sequence $\{r_n\}$ of values of r , tending to infinity.

In other words,

$$\frac{\log \log M(r)}{\log r} < \rho + \varepsilon \quad \forall r > r_0 \text{ and} \quad (111)$$

$$\frac{\log \log M(r)}{\log r} > \rho - \varepsilon \quad (112)$$

for a sequence of values of $r \rightarrow +\infty$

(111) and (112) precisely means

$$\rho = \limsup_{r \rightarrow \infty} \frac{\log \log M(r)}{\log r}$$

Example 3 : Determine the order of the functions.

(i) $p(z) = a_0 + a_1z + \dots + a_nz^n$, $a_n \neq 0$. (ii) e^{kz} , $k \neq 0$.

(iii) $\sin z$ (iv) $\cos \sqrt{z}$

Solution :

$$(i) |p(z)| = |a_0 + a_1z + \dots + a_nz^n| \leq |a_0| + |a_1||z| + \dots + |a_n||z|^n$$

$$\text{Hence, } M(r) = \max_{|z|=r} |p(z)| \leq |a_0| + |a_1|r + \dots + |a_n|r^n$$

$\leq r^n (|a_0| + \dots + |a_n|)$ (choosing $r \geq 1$. Since ultimately $r \rightarrow \infty$, the choice is justified).

$= Br^n$, where $B = |a_0| + \dots + |a_n|$. Hence

$\log M(r) \leq \log B + n \log r \leq \log r + n \log r$ (Taking r sufficiently large).

$= (n + 1) \log r$. Now,

$$\rho = \limsup_{r \rightarrow \infty} \frac{\log \log M(r)}{\log r} \leq \limsup_{r \rightarrow \infty} \frac{\log(n+1) + \log \log r}{\log r} = 0$$

i.e. $\rho \leq 0$. But by definition $\rho \geq 0$. Hence $\rho = 0$

(ii) Here $M(r) = e^{k|r|}$ and hence

$$\rho = \limsup_{r \rightarrow \infty} \frac{\log \log M(r)}{\log r} = \limsup_{r \rightarrow \infty} \frac{\log(|k|r)}{\log r} = 1$$

(iii) We know that

$$\sin z = z - \frac{z^3}{3!} + \frac{z^5}{5!} - \dots$$

and so

$$|\sin z| \leq |z| + \frac{|z|^3}{3!} + \frac{|z|^5}{5!} + \dots = r + \frac{r^3}{3!} + \frac{r^5}{5!} + \dots = \sinh r \text{ on } |z| \leq r.$$

$$= \frac{e^r - e^{-r}}{2}. \text{ Also at } z = ir, \sin z = \frac{e^{-r} - e^r}{2i} \text{ and so } |\sin z| = \frac{e^r - e^{-r}}{2}.$$

$$\text{Hence } M(r) = \frac{e^r - e^{-r}}{2} = \frac{e^r(1 - e^{-2r})}{2}$$

$$\log M(r) = r + \log\left(\frac{1 - e^{-2r}}{2}\right) = r \left\{ 1 + \frac{1}{r} \log\left(\frac{1 - e^{-2r}}{2}\right) \right\}$$

Therefore,

$$\lim_{r \rightarrow \infty} \frac{\log \log M(r)}{\log r} = \lim_{r \rightarrow \infty} \left[1 + \log \left\{ 1 + \frac{1}{r} \log\left(\frac{1 - e^{-2r}}{2}\right) \right\} / \log r \right] = 1$$

So order of $\sin z$ is 1.

(iv) Following as in (iii) we find that the order of $\cos \sqrt{z} = 1/2$.

Let $f(z) = \sum_{n=0}^{\infty} a_n z^n$ be an entire function. We now state a theorem which will give us order of $f(z)$ in terms of the coefficients a_n of the power series expansion of $f(z)$.

Theorem : Let $f(z) = \sum_{n=0}^{\infty} a_n z^n$ be an entire function of finite order ρ . Then,

$$\rho = \limsup_{n \rightarrow \infty} \frac{-\log n}{\log |a_n|^{1/n}} = \limsup_{n \rightarrow \infty} \frac{-n \log n}{\log |a_n|}$$

6.8 The function $n(r)$

Let $f(z)$ be an entire function with zeros at the points a_1, a_2, \dots , arranged in order of non-decreasing modulus, i.e. $|a_1| \leq |a_2| \leq \dots$, multiple zeros being repeated according to

their multiplicities. We define the function $n(r)$ to be the number of zeros of $f(z)$ in $|z| \leq r$. Evidently $n(r)$ is a non-decreasing, non-negative function of r which is constant in any interval which does not contain the modulus of a zero of $f(z)$. We observe that if $f(0) \neq 0$, $n(r) = 0$ for $r < |a_1|$. Also, $n(r) = n$ for $|a_n| \leq r < |a_{n+1}|$.

Jensen's inequality can also be written in the following form involving $n(r)$.

Theorem 6.12 (Jensen's inequality) : Let $f(z)$ be an entire function with $f(0) \neq 0$, and a_1, a_2, \dots be the zeros of $f(z)$ such that $|a_1| \leq |a_2| \leq \dots$, multiple zeros being repeated according to their multiplicities. If $|a_N| \leq r < |a_{N+1}|$, then

$$\log \frac{r^N}{|a_1 \cdots a_N|} = \int_0^r \frac{n(x)}{x} dx \leq \log M(r) - \log |f(0)| \quad (113)$$

Proof : Let $|a_i| = r_i$, $i = 1, 2, \dots$, and r be a positive number such that $r_N \leq r < r_{N+1}$. Let x_1, \dots, x_m be the distinct numbers of the set $A = \{r_1, \dots, r_N\}$ where $x_1 = r_1, \dots, x_m = r_N$. Suppose x_i is repeated p_i times in A . Then, $p_1 + \dots + p_m = N$. Also let $t_i = p_1 + \dots + p_i$, $i = 1, \dots, m$.

We now consider two cases.

Case 1) Let $r_N < r$. Then,

$$\begin{aligned} \int_0^r \frac{n(x)}{x} dx &= \lim_{\varepsilon \rightarrow 0} \left\{ \int_{x_1}^{x_2 - \varepsilon} \frac{n(x)}{x} dx + \int_{x_2}^{x_3 - \varepsilon} \frac{n(x)}{x} dx + \dots + \int_{x_{m-1}}^{x_m - \varepsilon} \frac{n(x)}{x} dx \right\} + \int_{x_m}^r \frac{n(x)}{x} dx \\ & \text{(since } \int_0^{x_1 - \varepsilon} \frac{n(x)}{x} dx = 0 \text{ as } n(x) = 0 \text{ for } 0 \leq x < x_1). \\ &= \lim_{\varepsilon \rightarrow 0} \left\{ \int_{x_1}^{x_2 - \varepsilon} \frac{t_1}{x} dx + \int_{x_2}^{x_3 - \varepsilon} \frac{t_2}{x} dx + \dots + \int_{x_{m-1}}^{x_m - \varepsilon} \frac{t_{m-1}}{x} dx \right\} + \int_{r_N}^r \frac{N}{x} dx \\ &= \lim_{\varepsilon \rightarrow 0} \left\{ [t_1 \log x]_{x_1}^{x_2 - \varepsilon} + [t_2 \log x]_{x_1}^{x_3 - \varepsilon} + \dots + [t_{m-1} \log x]_{x_{m-1}}^{x_m - \varepsilon} + [N \log x]_{r_N}^r \right\} \\ &= \lim_{\varepsilon \rightarrow 0} [t_1 \{ \log(x_2 - \varepsilon) - \log x_1 \} + t_2 \{ \log(x_3 - \varepsilon) - \log x_2 \} + \\ & \quad \dots + t_{m-1} \{ \log(x_m - \varepsilon) - \log x_{m-1} \}] + N(\log r - \log r_N) \\ &= t_1 (\log x_2 - \log x_1) + t_2 (\log x_3 - \log x_2) + \dots \\ & \quad + t_{m-1} (\log x_m - \log x_{m-1}) + N(\log r - \log r_N) \\ &= p_1 \log x_2 - p_1 \log x_1 + (p_1 + p_2) \log x_1 - (p_1 + p_2) \log x_2 + \dots + (p_1 + \dots + p_{m-1}) \\ & \quad \log x_m - (p_1 + \dots + p_{m-1}) \log x_{m-1} + N \log r - (p_1 + \dots + p_m) \log x_m \\ &= N \log r - (p_1 \log x_1 + p_2 \log x_2 + \dots + p_m \log x_m) \end{aligned}$$

$$\begin{aligned}
&= \log r^N - \log x_1^{p_1} x_2^{p_2} \cdots x_m^{p_m} = \log \frac{r^N}{x_1^{p_1} x_2^{p_2} \cdots x_m^{p_m}} \\
&= \log \frac{r^N}{r_1 \cdots r_N} \quad \text{Thus,} \\
&\int_0^r \frac{n(x)}{x} dx = \log \frac{r^N}{|a_1 \cdots a_N|} \tag{114}
\end{aligned}$$

Case 2). Let $r_N = r$. As before,

$$\begin{aligned}
\int_0^r \frac{n(x)}{x} dx &= \lim_{\varepsilon \rightarrow 0} \left\{ \int_{x_1}^{x_2 - \varepsilon} \frac{t_1}{x} dx + \cdots + \int_{x_{m-1}}^{x_m - \varepsilon} \frac{t_{m-1}}{x} dx \right\} \\
&= \sum_{i=1}^{m-1} t_i (\log x_{i+1} - \log x_i) + t_m (\log r - \log r_N) \\
&= \log \frac{r^N}{|a_1 \cdots a_N|} \quad (\text{Proceeding as in case 1}).
\end{aligned}$$

Thus in any case,

$$\begin{aligned}
\int_0^r \frac{n(x)}{x} dx &= \log \frac{r^N}{|a_1 \cdots a_N|}. \quad \text{But Jensen's inequality gives us} \\
\frac{r^N}{|a_1 \cdots a_N|} &\leq \frac{M(r)}{|f(0)|}. \quad \text{Hence,} \\
\int_0^r \frac{n(x)}{x} dx &= \log \frac{r^N}{|a_1 \cdots a_N|} \leq \log M(r) - \log |f(0)|.
\end{aligned}$$

Theorem 6.13 : If $f(z)$ be an entire function with finite order ρ , then $n(r) = O(r^{\rho + \varepsilon})$ for $\varepsilon > 0$ and for sufficiently large values of r .

Proof : By Jensen's inequality,

$$\int_0^r \frac{n(x)}{x} dx \leq \log M(r) - \log |f(0)| \tag{115}$$

We replace r by $2r$ in (115) and obtain

$$\int_0^{2r} \frac{n(x)}{x} dx \leq \log M(2r) - \log |f(0)| \tag{116}$$

Since order of $f(z)$ is ρ we have for any $\varepsilon > 0$,

$\log M(2r) < (2r)^{\rho + \varepsilon} = Kr^{\rho + \varepsilon}$ for all large r , K being a constant. Hence from (116).

$\int_0^{2r} \frac{n(x)}{x} dx < Ar^{\rho+\varepsilon}$ for all large r , A being a constant independent of r . Since $n(x)$ is non-negative and non-decreasing function of x , $\int_r^{2r} \frac{n(x)}{x} dx \leq \int_0^{2r} \frac{n(x)}{x} dx < Ar^{\rho+\varepsilon}$ and also $\int_r^{2r} \frac{n(x)}{x} dx \geq \int_r^{2r} \frac{n(r)}{x} dx = n(r) \log 2$.
Hence, $n(r) \log 2 \leq \int_r^{2r} \frac{n(x)}{x} dx < Ar^{\rho+\varepsilon}$,
i.e., $n(r) < \frac{A}{\log 2} r^{\rho+\varepsilon}$ for all large r . Hence, $n(r) = O(r^{\rho+\varepsilon})$.

6.9 Convergence exponent (or, exponent of Convergence)

Let $f(z)$ be an entire function with zeros at the points a_1, a_2, \dots , arranged in order of non-decreasing modulus, multiple zeros being repeated according to their multiplicities and $|a_i| = r_i, i = 1, 2, \dots$. We define convergence exponent ρ_1 of the zeros of $f(z)$ by the equation

$$\rho_1 = \limsup_{n \rightarrow \infty} \frac{\log n}{\log r_n} \quad (117)$$

or, equivalently by $\rho_1 = \limsup_{n \rightarrow \infty} \frac{\log n(r)}{\log r}$ (118)

The convergence exponent has the following property.

Theorem 6.14 : Let $f(z)$ be an entire function with zeros at a_1, a_2, \dots , arranged in order of non-decreasing modulus, multiple zeros being repeated according to their multiplicities and $|a_i| = r_i$. If the convergence exponent ρ_1 of the zeros of $f(z)$ is finite, then the series $\sum_{n=1}^{\infty} \frac{1}{r_n^\alpha}$ converges when $\alpha > \rho_1$ and diverges when $\alpha < \rho_1$.

If ρ_1 is infinite, the above series diverges for all positive values of α .

Proof : Let ρ_1 be finite and $\alpha > \rho_1$. Then, $\rho_1 < \frac{1}{2}(\rho_1 + \alpha)$.

Hence, $\frac{\log n}{\log r_n} < \frac{1}{2}(\rho_1 + \alpha)$ for all large n .

or, $\log n < \log r_n^{\frac{1}{2}(\rho_1 + \alpha)}$, i.e.

$n < r_n^{\frac{1}{2}(\rho_1 + \alpha)}$; or, $\frac{2}{n^{\rho_1 + \alpha}} < r_n$ i.e.,

$r_n^\alpha > \frac{2\alpha}{n^{\rho_1 + \alpha}} = n^{\frac{\alpha - \rho_1}{\alpha + \rho_1}} = n^{1+p}$, where $p = \frac{\alpha - \rho_1}{\alpha + \rho_1} > 0$.

Hence, $\frac{1}{r_n^\alpha} < \frac{1}{n^{1+p}}$ for all large n . Hence,

$\sum_{n=1}^{\infty} \frac{1}{r_n^\alpha}$ converges.

Next, let $\alpha < \rho_1$. Then, $\frac{\log n}{\log r_n} > \alpha$ for a sequence of values of n , tending to infinity.

That is, $\log n > \log r_n^\alpha$

or, $\frac{1}{r_n^\alpha} > \frac{1}{n}$ (119)

for a sequence of values of n tending to infinity.

Let N be such a value of n for which (119) holds and m be the least integer $> \frac{N}{2}$.

Then, as r_n is non-decreasing,

$$\sum_{n=N-m}^N \frac{1}{r_n^\alpha} = \frac{1}{r_{N-m}^\alpha} + \frac{1}{r_{N-m+1}^\alpha} + \dots + \frac{1}{r_N^\alpha} \geq \frac{1}{r_N^\alpha} + \dots + \frac{1}{r_N^\alpha}$$

$= \frac{m+1}{r_N^\alpha} > \frac{m}{r_N^\alpha} > \frac{m}{N} > \frac{1}{2}$. Since N may be as large as we please, by Cauchy's principle

of convergence, the series $\sum_{n=1}^{\infty} \frac{1}{r_n^\alpha}$ diverges.

If ρ_1 is infinite, then for any positive value of α , $\frac{\log n}{\log r_n} > \alpha$ for a sequence of values

of n tending to infinity; i.e., $n > r_n^\alpha$ for a sequence of values of n tending to infinity. Hence as before, the series $\sum_{n=1}^{\infty} \frac{1}{r_n^\alpha}$ diverges for any positive α .

Note 1. Observe that ρ_1 may also be defined as the lower bound of the positive numbers α for which the series $\sum_{n=1}^{\infty} \frac{1}{r_n^\alpha}$ is convergent. If $f(z)$ has no zeros we define $\rho_1 = 0$ and if $\sum_{n=1}^{\infty} \frac{1}{r_n^\alpha}$ diverges for all positive α , then $\rho_1 = \infty$.

Note 2. If ρ_1 is finite, the series $\sum_{n=1}^{\infty} \frac{1}{r_n^{\rho_1}}$ may be convergent or divergent. For example, if $r_n = n$, then $\rho_1 = \limsup_{n \rightarrow \infty} \frac{\log n}{\log r_n} = 1$

and $\sum_{n=1}^{\infty} \frac{1}{r_n^{\rho_1}} = \sum_{n=1}^{\infty} \frac{1}{n}$ diverges. Again, if $r_n = n(\log n)^2$,

then, $\rho_1 = \limsup_{n \rightarrow \infty} \frac{\log n}{\log n + 2 \log \log n} = 1$, and

$\sum_{n=1}^{\infty} \frac{1}{r_n^{\rho_1}} = \sum_{n=1}^{\infty} \frac{1}{n(\log n)^2}$ converges.

Theorem 6.15 : If $f(z)$ is an entire function with finite order ρ and r_1, r_2, \dots , are the moduli of the zeros of $f(z)$,

then $\sum_{n=1}^{\infty} \frac{1}{r_n^\alpha}$ converges if $\alpha > \rho$.

Proof : We choose β such that $\rho < \beta < \alpha$. Since for any $\varepsilon > 0$,

$$n(r) = O(r^{\rho + \varepsilon}), \quad n(r) < Kr^\beta \quad (120)$$

for all large r , K being a constant.

Putting $r = r_n$, n large, (120) gives $n < Kr_n^\beta$, i.e.,

$$r_n > \frac{n^{1/\beta}}{k^{1/\beta}} \quad \text{or,} \quad \frac{1}{r_n^\alpha} < \frac{B}{n^{\alpha/\beta}} \quad \text{for all large } n, \quad B \text{ being a constant. Since } \frac{\alpha}{\beta} > 1, \quad \sum_{n=1}^{\infty} \frac{1}{r_n^\alpha}$$

converges.

Corollary : Since convergence exponent ρ_1 is the lower bound of positive numbers

α for which $\sum_{n=1}^{\infty} \frac{1}{r_n^\alpha}$ is convergent, it follows that $\rho_1 \leq \rho$.

Note : ρ_1 may be 0 or ∞ . For example if $r_n = e^n$, $\rho_1 = 0$ and if $r_n = \log n$, then $\rho_1 = \infty$. For the function $f(z) = e^z$, $\rho = 1$ and $\rho_1 = 0$ so that $\rho_1 < \rho$. But for $\sin z$ or $\cos z$, $\rho = \rho_1 = 1$.

Result : If the convergence exponent ρ_1 of the zeros of an entire function $f(z)$ is greater than 0, then $f(z)$ has infinite number of zeros.

Proof : If possible, suppose $f(z)$ has finite number of zeros with moduli r_1, \dots, r_N . The series $\sum_{n=1}^N \frac{1}{r_n^\alpha}$, being of finite number of terms, converges for every $\alpha > 0$. Hence $\rho_1 = 0$, a contradiction. Hence $f(z)$ has infinite number of zeros.

Note : For an entire function with finite number of zeros, $\rho_1 = 0$.

Example : Find the convergence exponent of the zeros of $\cos z$.

Solution : First method : The zeros of $\cos z$ are $\frac{\pi}{2}, -\frac{\pi}{2}, \frac{3\pi}{2}, -\frac{3\pi}{2}, \dots$

$$\text{Now, } \sum_{n=1}^{\infty} \frac{1}{r_n^\alpha} = \left(\frac{2}{\pi}\right)^\alpha + \left(\frac{2}{\pi}\right)^\alpha + \left(\frac{2}{\pi}\right)^\alpha \cdot \frac{1}{3^\alpha} + \dots$$

$$= 2 \left(\frac{2}{\pi}\right)^\alpha \left(1 + \frac{1}{3^\alpha} + \frac{1}{5^\alpha} + \dots\right). \text{ The series } \frac{1}{1^\alpha} + \frac{1}{3^\alpha} + \frac{1}{5^\alpha} + \dots$$

converges when $\alpha > 1$ and diverges when $\alpha < 1$. Hence the lower bound of the positive numbers α for which $\sum_{n=1}^{\infty} \frac{1}{r_n^\alpha}$ converges is 1 i.e., $\rho_1 = 1$.

Second method : The zeros of $\cos z$ are $(2n + 1) \frac{\pi}{2}$,

$$n = 0, \pm 1, \pm 2, \dots; \text{ i.e. } \frac{\pi}{2}, -\frac{\pi}{2}, \frac{3\pi}{2}, -\frac{3\pi}{2}, \dots$$

$$\text{Let } a_1 = \frac{\pi}{2}, a'_1 = -\frac{\pi}{2}, a_2 = \frac{3\pi}{2}, a'_2 = -\frac{3\pi}{2}, \dots,$$

$$a_n = (2n - 1) \frac{\pi}{2}, a'_n = -(2n - 1) \frac{\pi}{2}, \dots, \text{ Hence,}$$

$$r_1 = |a_1| = |a'_1| = \frac{\pi}{2}, r_2 = |a_2| = |a'_2| = \frac{3\pi}{2}, \dots, r_n = |a_n| = |a'_n| =$$

$$\begin{aligned}
& (2n-1)\frac{\pi}{2}, \dots \text{ Hence, } \rho_1 = \limsup_{n \rightarrow \infty} \frac{\log n}{\log r_n} \\
& = \limsup_{n \rightarrow \infty} \frac{\log n}{\log(2n-1) + \log \frac{\pi}{2}} = \limsup_{n \rightarrow \infty} \frac{\log n}{\log \left\{ n \left(2 - \frac{1}{n} \right) \right\} + \log \frac{\pi}{2}} \\
& = \limsup_{n \rightarrow \infty} \frac{1}{1 + \frac{\log \left(2 - \frac{1}{n} \right)}{\log n} + \frac{\log \pi / 2}{\log n}} = 1.
\end{aligned}$$

6.10 Canonical Product

Let $f(z)$ be an entire function with infinite number of zeros at $a_n, n = 1, 2, \dots, a_n \neq 0$. If there exists a least non-negative integer p such that the series $\sum_{n=1}^{\infty} \frac{1}{r_n^{p+1}}$ is convergent, where $r_n = |a_n|$, we form the infinite product $G(z) = \prod_{n=1}^{\infty} E\left(\frac{z}{a_n}, p\right)$. By Weierstrass' factor theorem $G(z)$ represents an entire function having zeros precisely at the points a_n . We call $G(z)$ as the Canonical product corresponding to the sequence $\{a_n\}$ and the integer p is called its genus. If $z = 0$ is a zero of $f(z)$ of order m , then the canonical product is $z^m G(z)$.

Observe that if the convergence exponent $\rho_1 \neq$ an integer, then $p = [\rho_1]$ and if ρ_1 is an integer, then $p = \rho_1$ when $\sum_{n=1}^{\infty} \frac{1}{r_n^{\rho_1}}$ is divergent and $p = \rho_1 - 1$ if $\sum_{n=1}^{\infty} \frac{1}{r_n^{\rho_1}}$ is convergent.

In any case, $\rho_1 - 1 \leq p \leq \rho_1 \leq \rho$, where $\rho =$ order of $f(z)$.

Examples : (i) Let $a_n = n$. Then $\sum_{n=1}^{\infty} \frac{1}{r_n^2} = \sum_{n=1}^{\infty} \frac{1}{n^2}$ is convergent while $\sum_{n=1}^{\infty} \frac{1}{r_n} = \sum_{n=1}^{\infty} \frac{1}{n}$ is divergent. So, $p = 1$.

(ii) Let $a_n = e^n$. Then $p = 0$.

We now state an important theorem without proof. The proof can be found in any standard book.

Borel's theorem : The order of a canonical product is equal to the convergence exponent of its zeros.

Example : Find the canonical product of $f(z) = \sin z$.

Solution : $f(z)$ is an entire function with infinite number of zeros at $z = n\pi$, n being an integer. First we consider the zeros of $f(z)$ excluding the simple zero at $z = 0$. Let $a_n = n\pi$, $n = \pm 1, \pm 2, \dots$

$$|a_n| = r_n. \text{ Then, } r_n = |n\pi|. \text{ Now, } \sum_{n=1}^{\infty} \frac{1}{r_n} = \sum_{n=1}^{\infty} \frac{1}{|n\pi|}$$

$$= \frac{1}{\pi} \sum_{n=1}^{\infty} \frac{1}{n} \text{ is divergent, but } \sum_{n=1}^{\infty} \frac{1}{r_n^2} = \frac{1}{\pi^2} \sum_{n=1}^{\infty} \frac{1}{n^2} \text{ is convergent. Hence genus of the}$$

required canonical product $p = 1$.

Hence the canonical product $G(z)$ is given by

$$G(z) = \prod_{n=-\infty}^{\infty} E\left(\frac{z}{a_n}, 1\right), \text{ where } \prod'_{n=-\infty}^{\infty} \text{ means } n = 0 \text{ is excluded in the product.}$$

$$= \prod'_{n=-\infty}^{\infty} \left(1 - \frac{z}{n\pi}\right) e^{\frac{z}{n\pi}} = \prod'_{n=1}^{\infty} \left\{ \left(1 - \frac{z}{n\pi}\right) e^{\frac{z}{n\pi}} \cdot \left(1 - \frac{z}{n\pi}\right) e^{-\frac{z}{n\pi}} \right\}$$

$= \prod'_{n=-\infty}^{\infty} \left(1 - \frac{z^2}{n^2\pi^2}\right)$. Since origin is a simple zero of $\sin z$, the required canonical product of $\sin z$ is given by

$$\sin z = z \prod_{n=1}^{\infty} \left(1 - \frac{z^2}{n^2\pi^2}\right).$$

Exercises

1. Find the order of the entire functions :

(a) $\sinh z$ (b) $e^z \sin z$, (c) e^{z^n} , (d) e^{e^z} , (e) $\cos z$, (f) $e^{p(z)}$, where $p(z) = a_0 + a_1z + \dots + a_nz^n$, $a_n \neq 0$, (g) $\sum_{n=0}^{\infty} \frac{z^n}{(n!)^\alpha}$, $\alpha > 0$, (h) $\sum_{n=0}^{\infty} \left(\frac{e\alpha}{n}\right)^{n/\alpha} z^n$, $\alpha > 0$

2. Given $f_1(z)$ and $f_2(z)$ are two entire functions of orders ρ_1 and ρ_2 respectively, show that (i) order of $f_1(z) f_2(z)$ is $\leq \max(\rho_1, \rho_2)$ (ii) order of $f_1(z) + f_2(z)$ is $\leq \max(\rho_1, \rho_2)$, and equality occurs if $\rho_1 \neq \rho_2$.

3. Find the convergence exponent of the zeros of $\sin z$.

4. Find the canonical product of $\cos z$.

5. Show that if $a > 1$, the entire function $\prod_{n=1}^{\infty} \left(1 - \frac{z}{n^a}\right)$ is of order $\frac{1}{a}$.

6.11 Hadamard's Factorization Theorem

Before taking up Hadamard's factorization theorem we state a theorem due to Borel and Caratheodory.

Borel and Caratheodory's theorem : Let $f(z)$ be analytic in

$$|z| \leq R, M(r) = \max_{|z|=r} |f(z)|, A(r) = \max_{|z|=r} \{\operatorname{Re} f(z)\}.$$

Then for $0 < r < R$,

$$M(r) \leq \frac{2r}{R-r} A(R) + \frac{R+r}{R-r} |f(0)| < \frac{R+r}{R-r} \{A(R) + |f(0)|\} \quad (121)$$

Proof : Omitted (cf. Theory of entire functions—A.S.B Holland- p. 53).

$$\text{Corollary : } \max_{|z|=r} |f^{(n)}(z)| \leq \frac{2^{n+2} \cdot n! R}{(R-r)^{n+1}} (A(R) + |f(0)|) \quad (122)$$

Hadamard's Factorization Theorem 6.16 :

If $f(z)$ is an entire function of finite order ρ with infinite number of zeros and $f(0) \neq 0$, then $f(z) = e^{Q(z)} G(z)$, where $G(z)$ is the canonical product formed with the zeros of $f(z)$ and $Q(z)$ is a polynomial of degree not greater than ρ .

Proof : By Weierstrass' factor theorem we already have

$$f(z) = e^{Q(z)} G(z) \quad (123)$$

where $G(z)$ is the canonical product with genus p formed with the zeros a_1, a_2, \dots of $f(z)$ and $Q(z)$ is an entire function. Since ρ is finite we need to show that $Q(z)$ is a polynomial of degree $\leq \rho$. Let $m = [\rho]$. Then, $p \leq m$. Taking logarithms on both sides of (123) we have,

$$\begin{aligned} \log f(z) &= Q(z) + \log G(z) \\ &= Q(z) + \sum_{n=1}^{\infty} \log \left(1 - \frac{z}{a_n}\right) + \sum_{n=1}^{\infty} \left\{ \frac{z}{a_n} + \frac{1}{2} \left(\frac{z}{a_n}\right)^2 + \dots + \frac{1}{p} \left(\frac{z}{a_n}\right)^p \right\} \end{aligned} \quad (124)$$

Differentiating both sides of (124) $m + 1$ times,

$$\frac{d^m}{dz^m} \left(\frac{f'(z)}{f(z)} \right) = Q^{(m+1)}(z) - m! \sum_{n=1}^{\infty} \frac{1}{(a_n - z)^{m+1}} \quad (125)$$

$$[\text{Since } p \leq m, \frac{d^{m+1}}{dz^{m+1}} \sum_{n=1}^{\infty} \left\{ \frac{z}{a_n} + \frac{1}{2} \left(\frac{z}{a_n} \right)^2 + \dots + \frac{1}{p} \left(\frac{z}{a_n} \right)^p \right\} = 0$$

$$\text{and } \frac{d^{m+1}}{dz^{m+1}} \log \left(1 - \frac{z}{a_n} \right) = \frac{d^{m+1}}{dz^{m+1}} \log(a_n - z) = -m! \frac{1}{(a_n - z)^{m+1}}]$$

Now, $Q(z)$ will be a polynomial of degree m at most if we can show that $Q^{(m+1)}(z) = 0$.

Let $g_R(z) = \frac{f(z)}{f(0)} \prod_{|a_n| \leq R} \left(1 - \frac{z}{a_n} \right)^{-1}$. Then $g_R(z)$ is an entire function and $g_R(z) \neq 0$ in

$|z| \leq R$. [Since $f(z)$ is entire, $f(0) \neq 0$ and $\prod_{|a_n| \leq R} \left(1 - \frac{z}{a_n} \right)^{-1}$ cancels with factors in $f(z)$].

For $|z| = 2R$ and $|a_n| \leq R$ we have, $\left| 1 - \frac{z}{a_n} \right| \geq 1$. Hence,

$$|g_R(z)| \leq \frac{|f(z)|}{|f(0)|} < Ae^{(2R)^{\rho+\epsilon}} \text{ for } |z| = 2R \quad (126)$$

$$\text{By maximum modulus theorem, } |g_R(z)| < Ae^{(2R)^{\rho+\epsilon}} \quad (127)$$

for $|z| < 2R$. Let $h_R(z) = \log g_R(z)$ such that $h_R(0) = 0$.

Then $h_R(z)$ is analytic in $|z| \leq R$. Hence from (127)

$$\text{Re } h_R(z) = \log |g_R(z)| < KR^{\rho+\epsilon}, \quad K = \text{Constant} \quad (128)$$

Hence from the corollary of the theorem of Borel and Caratheodory we have

$$|h_R^{(m+1)}(z)| \leq \frac{2^{m+3}(m+1)!R}{(R-r)^{m+2}} \cdot KR^{\rho+\epsilon} \text{ for } |z| = r < R$$

Hence for $|z| = r = \frac{R}{2}$,

$$|h_R^{(m+1)}(z)| = O(R^{\rho+\epsilon-m-1}) \quad (129)$$

But $h_R(z) = \log g_R(z) = \log f(z) - \log f(0) - \sum_{|a_n| \leq R} \log \left(1 - \frac{z}{a_n}\right)$

$$\begin{aligned} \text{Hence } h_R^{(m+1)}(z) &= \frac{d^m}{dz^m} \left(\frac{f'(z)}{f(z)} \right) + m! \sum_{|a_n| \leq R} \frac{1}{(a_n - z)^{m+1}} \\ &= O(R^{\rho+\varepsilon-m-1}) + O \left(\sum_{|a_n| > R} \frac{1}{|a_n|^{m+1}} \right) \end{aligned} \quad (130)$$

for $|z| = \frac{R}{2}$ and so also for $|z| < \frac{R}{2}$ by maximum modulus theorem. The first term on the right of (130) tends to 0 as $R \rightarrow \infty$ if $\varepsilon > 0$ is small enough since $m + 1 > \rho$. Also the second term tends to 0 since $\sum_{n=1}^{\infty} \frac{1}{|a_n|^{m+1}}$ is convergent.

In fact, $\sum_{|a_n| > R} \frac{1}{|a_n|^{m+1}}$ becomes the remainder term for large R .

Hence $Q^{(m+1)}(z) = 0$ since $Q^{(m+1)}(z)$ is independent of R .

Thus, $Q(z)$ is a polynomial of degree not greater than ρ .

6.12 Consequences of Hadamard's Theorem

Theorem 6.17 : An entire function of finite order admits any finite complex number except, perhaps, one number.

Proof. Let us suppose that f does not admit two finite values a and b . Then $f(z) - a \neq 0$ for all z in \mathcal{C} and hence there exists an entire function $g(z)$ such that

$$f(z) - a = e^{g(z)}$$

The function $f(z) - a$ is of finite order since $f(z)$ has finite order. Following Hadamard's factorization theorem $g(z)$ must be a polynomial. Now $e^{g(z)}$ does not assume the value $b - a$ i.e. $g(z) \neq \log(b - a)$ for any z in \mathcal{C} . As because $g(z)$ is a polynomial it contradicts the essence of the Fundamental Theorem of Algebra [(14), Th. 3.11, page-65].

Theorem 6.18 : An entire function of fractional order possesses infinitely many zeros.

Proof. Let f be an entire function of fractional order ρ . If possible, suppose the zeros of $f(z)$ are $\{a_1, a_2, \dots, a_n\}$, finite in number, counted according to their multiplicity. Then $f(z)$ can be expressed as

$$f(z) = e^{g(z)} (z - a_1) (z - a_2) \dots (z - a_n)$$

where $g(z)$ is an entire function. Applying Hadamard's factorization theorem, the degree of the polynomial $g(z) \leq \rho$. It is easy to check that $f(z)$ and $e^{g(z)}$ are of same order. But we have already seen that the order of $e^{g(z)}$ is exactly the degree of $g(z)$, which is an integer. This implies ρ is an integer. This contradiction completes the proof.

6.13 Meromorphic Functions

The term meromorphic comes from the **Ancient Greek** “meros” meaning part, as opposed to “holos” meaning whole. This function is analytic on a domain D except a set of isolated points, which are poles for the function.

Definition : A function $f(z)$ analytic in a domain D except for poles is said to be meromorphic.

Theorem 6.19 : A rational function is meromorphic.

Proof : Let $f(z) = p(z)/q(z)$ where p and q are polynomials with no common zeros. If the degree of p is less than or equal to the degree of q , then f has only a finite number of poles and the point at infinity is not a pole. On the otherhand, if the degree of p is greater than the degree of q , then (taking degree of $p(z) = m$ and degree of $q(z) = n$).

$$\begin{aligned} f(z) &= \frac{a_m z^m + a_{m-1} z^{m-1} + \dots + a_1 z + a_0}{b_n z^n + b_{n-1} z^{n-1} + \dots + b_1 z + b_0} \\ &= c_{m-n} z^{m-n} + c_{m-n-1} z^{m-n-1} + \dots + c_1 z + c_0 + \frac{r(z)}{q(z)} \end{aligned}$$

where degree of $r(z) \leq n - 1$. This shows that the point at infinity is a pole of order $(m - n)$ and there lie a finite number of poles in the unextended plane. These establish that $f(z)$ is meromorphic.

Theorem 6.20 : [Partial fraction decomposition]. Let $p(z)$, $q(z)$ be two polynomials with no common zeros and that $0 \leq \deg(p) < \deg(q)$. Let a_1, \dots, a_k be the zeros of $q(z)$ with multiplicities $\alpha_1, \dots, \alpha_k$. Then $p(z)/q(z)$ can be expressed uniquely as

$$\frac{p(z)}{q(z)} = \sum_{i=1}^k \sum_{j=1}^{\alpha_i} \frac{c_{ij}}{(z - a_i)^j} \quad (131)$$

Proof. The decomposition is unique. We assume that the relation (131) exists. Let $r > 0$ be small enough. Then for $z \in N(a_i, r)$, (131) can be rewritten as

$$\frac{p(z)}{q(z)} = g(z) + \sum_{j=1}^{\alpha_i} \frac{c_{ij}}{(z - a_i)^j} \quad (132)$$

since $N(a_i, r)$ does not contain any zero of $q(z)$ other than a_i , $g(z)$ is analytic at $z = a_i$.

Multiplying both sides of (132) by $(z - a_i)^{\alpha_i}$, we obtain

$$\frac{p(z)}{q(z)} (z - a_i)^{\alpha_i} = g(z)(z - a_i)^{\alpha_i} + \sum_{j=1}^{\alpha_i} c_{ij} (z - a_i)^{\alpha_i - j} \quad (133)$$

Now the function $\frac{p(z)}{q(z)} (z - a_i)^{\alpha_i}$ is analytic for all z belonging to $N(a_i, r)$ and hence can be expanded in a Taylor series in a neighbourhood of a_i in $N(a_i, r)$

$$\frac{p(z)}{q(z)} (z - a_i)^{\alpha_i} = \sum_{n=0}^{\infty} c_n (z - a_i)^n \quad (134)$$

Combining (133) and (134), we write

$$\begin{aligned} \sum_{n=0}^{\alpha} c_n (z - a_i)^n &= g(z)(z - a_i)^{\alpha_i} + c_{i\alpha_i} + c_{i\alpha_i-1} (z - a_i) + \dots + \\ &+ c_{i1} (z - a_i)^{\alpha_i-1} \end{aligned}$$

Comparing the coefficients we find

$$c_1 \alpha_i = c_0, c_{i\alpha_i-1} = c_1, \dots, c_{i1} = c_{\alpha_i-1} \text{ uniquely}$$

Existence of the decomposition.

The principal part associated to each pole a_i is

$$\sum_{j=1}^{\alpha_i} \frac{c_{ij}}{(z - a_i)^j}$$

Now if we subtract all the principal parts we find the function

$$f(z) = \frac{p(z)}{q(z)} - \sum_{i=1}^k \sum_{j=1}^{\alpha_i} \frac{c_{ij}}{(z - a_i)^j}$$

is analytic in the extended plane. Now each of the terms

$$\frac{c_{ij}}{(z - a_i)^j}$$

converges to zero for $z \rightarrow \infty$, and also $p(z)/q(z)$ converges to zero for $z \rightarrow \infty$ since $\deg(q) > \deg(p)$. This shows that $f(z) \rightarrow 0$ for $z \rightarrow \infty$. But then f is necessarily

bounded and hence constant by Liouville's theorem. A constant function tending to zero as $z \rightarrow \infty$ must be identically zero.

Example 4 : Consider the rational function

$$\frac{p(z)}{q(z)} = \frac{2z^3 + (5i + 3)z^2 + (3 - 5i)}{z^4 - 1}$$

We can write this as

$$\begin{aligned} \frac{p(z)}{q(z)} &= \frac{\alpha}{z-1} + \frac{\beta}{z+1} + \frac{\gamma}{z-i} + \frac{\delta}{z+i} \\ &= g_1(z) + \frac{\alpha}{z-1} \end{aligned} \tag{135}$$

considering z belonging to $|z - 1| < 1$. Then

$$\frac{p(z)}{q(z)}(z-1) = g_1(z)(z-1) + \alpha \Rightarrow \alpha = 2$$

6.14 Partial Fraction Expansion of Meromorphic Functions

Let $f(z)$ be a meromorphic function and z_0 be a pole of order m with the principal part

$$p(z) = \frac{c_{-m}}{(z-z_0)} + \frac{c_{-m+1}}{(z-z_0)^{m+1}} + \dots + \frac{c_{-1}}{z-z_0}$$

Then $f(z)$ can be written as [see § 6.2, (14)]

$$f(z) = p(z) + g(z)$$

where $g(z)$ is an entire function. Now if, in general, z_1, z_2, \dots, z_n are the poles of a meromorphic function f with the corresponding principal parts P_1, P_2, \dots, P_n then f can be expressed as

$$f(z) = \sum_{j=1}^n P_j(z) + \psi(z) \tag{136}$$

where $\psi(z)$ is an entire function.

But the question arises whether it is possible to construct a meromorphic function possessing poles at the sequence of points $\{z_n\}$ with corresponding principal parts P_1, P_2, \dots . Because in this case the series $\sum P_j(z)$ in (136) turns out to be an infinite series $\sum_{j=1}^{\infty} P_j(z)$, which needs to be convergent.

Gösta Mittag Leffler (1846-1927), German in origin but his several generations lived in Sweden, overcame this difficulty by introducing a polynomial $p_n(z)$ dependent on z_n and $P_n(z)$ so that the series $\sum_{n=1}^{\infty} \{P_n(z) - p_n(z)\}$ is uniformly convergent in any compact set K not containing any points of the sequence $\{z_n\}$.

Theorem 6.21 [The Mittag Leffler Theorem] : Given a sequence of distinct complex numbers $\{z_n\}$,

$$|z_1| \leq |z_2| \leq \dots, \lim_{n \rightarrow \infty} z_n = \infty$$

and a sequence of rational functions $\{P_n(z)\}$,

$$P_n(z) = \sum_{k=1}^{l_n} \frac{c_{nk}}{(z - z_n)^k}, \quad l_n \geq 1, \quad n = 1, 2, \dots \quad (137)$$

there exists a meromorphic function $f(z)$ having poles at the points z_n and only there with $P_n(z)$ as its principal part at z_n and can be represented in the form of an expansion

$$f(z) = \sum_{n=1}^{\infty} [P_n(z) - p_n(z)] + h(z)$$

where $h(z)$ is an arbitrary entire function and $p_n(z)$ is suitable partial sum of Taylor's expansion of the singular part which is analytic in the open disc $|z| < |z_n|$.

Proof. Without loss of generality we assume that $z = 0$ is not a pole of $f(z)$. Now $P_k(z)$ is analytic for $|z| < |z_k|$ and can be expanded in this neighbourhood of z :

$$P_k(z) = \sum_{j=0}^{\infty} c_j^{(k)} z^j$$

and hence this series converges uniformly in the disk $|z| \leq |z_k|/2$. Let $p_k(z) = \sum_{j=0}^{\alpha_k} c_j^{(k)} z^j$ be a partial sum of this expansion such that

$$|P_k(z) - p_k(z)| < \frac{1}{k^2} \quad \text{for } |z| \leq |z_k|/2.$$

Let R be an arbitrary large positive number and since $z_n \rightarrow \infty$ as $n \rightarrow \infty$ we can find an $N(R)$ so large that $|z_n| > 2R$ when $n \geq N(R)$. Therefore in the circle $|z| < R < \frac{|z_N|}{2}$

$$\sum_{n=1}^{\infty} [P_n(z) - p_n(z)] = \sum_{n=1}^{N(R)-1} [P_n(z) - p_n(z)] + \sum_{n=N(R)}^{\infty} [P_n(z) - p_n(z)]$$

the first sum in the r.h.s is finite and the second sum $\sum_{N(R)}^{\infty}$ is absolutely and uniformly convergent by comparison with the convergent series $\sum_{n=N(R)}^{\infty} 2^{-n}$. Therefore $\sum_{n=1}^{\infty} [P_n(z) - p_n(z)]$ is analytic in $|z| < R$ except at the poles belonging to the sequence $\{z_n\}$. It is thus a meromorphic function with the poles at z_1, z_2, \dots and with the principal parts $P_1(z), P_2(z), \dots$ at each point z_n respectively. Now if $f(z)$ possesses the same poles only with the same principal parts then

$$f(z) - \sum_{n=1}^{\infty} [P_n(z) - p_n(z)]$$

is an entire function $h(z)$, say. This completes the proof.

Example 5 : Prove that

$$\pi \cot \pi z = \frac{1}{z} + \sum_{n=-\infty}^{\infty} ' \left\{ \frac{1}{z-n} + \frac{1}{n} \right\}$$

Solution : The given function $\pi \cot \pi z$ has simple poles at $z = 0, \pm 1, \pm 2, \dots$ with residue 1.

Here,

$$\frac{1}{z-n} = -\frac{1}{n} \frac{1}{\left(1 - \frac{z}{n}\right)} = -\frac{1}{n} \left(1 + \frac{z}{n} + \frac{z^2}{n^2} + \dots\right), |z| < n \quad (138)$$

Let $|z| < R$ and $N(R)$ be so large that $R < \frac{n}{2}$ when $n \geq N(R)$. Then from (138), we find

$$\left| \frac{1}{z-n} + \frac{1}{n} \right| \leq \frac{2R}{N^2}, \quad n \geq N$$

Now, since $\sum 1/N^2$ is convergent, the series

$$\sum_{n=-\infty}^{\infty} ' \left\{ \frac{1}{z-n} + \frac{1}{n} \right\}$$

converges uniformly on any compact set (lying in $|z| < R$) not containing any of the points $z = \pm 1, \pm 2, \dots$. Therefore applying the Mittag-Leffler theorem we can express

$$\pi \cot \pi z = \frac{1}{z} + \sum_{n=-\infty}^{\infty} ' \left\{ \frac{1}{z-n} + \frac{1}{n} \right\} + h(z) \quad (139)$$

where $h(z)$ is an entire function. Differentiating term-wise, we obtain

$$\begin{aligned}\pi^2 \operatorname{cosec}^2 \pi z &= \frac{1}{z^2} + \sum_{n=-\infty}^{\infty} ' \frac{1}{(z-n)^2} - h'(z) \\ &= \sum_{n=-\infty}^{\infty} \frac{1}{(z-n)^2} - h'(z)\end{aligned}$$

$$\text{and } h'(z) = \sum_{n=-\infty}^{\infty} \frac{1}{(z-n)^2} - \pi^2 \operatorname{cosec}^2 \pi z = f(z) - \psi(z), \text{ say} \quad (140)$$

We notice that the functions $f(z)$ and $\psi(z)$ are both periodic with period 1 and consequently $h'(z)$ is also periodic with the same period.

Let $z = x + iy$. Consider the strip $0 \leq x \leq 1$. In fact, the convergence of the series in (140) is uniform for $y \geq 1$, say and the limit tends to 0 as $y \rightarrow \infty$ (this can be seen on taking the limit in each term of the series).

$$\begin{aligned}\text{Again, } \sin(x + iy) &= \sin x \cos(iy) + \cos x \sin(iy) \\ &= \sin x \cosh y + i \cos x \sinh y\end{aligned}$$

and so

$$\begin{aligned}|\sin \pi z|^2 &= |\sin \pi(x + iy)|^2 \\ &= \sin^2 \pi x \cosh^2 \pi y + \cos^2 \pi x \sinh^2 \pi y \\ &= \cosh^2 \pi y - \cos^2 \pi x\end{aligned}$$

which establishes that $\pi^2 \operatorname{cosec}^2 \pi z$ tends uniformly to zero as $y \rightarrow \infty$. From these we conclude that $h'(z)$ is bounded in the period strip $0 \leq x \leq 1$ and due to its periodicity it is bounded in the entire plane. By Liouville's theorem it then reduces to a constant. Now since

$$\lim_{y \rightarrow \infty} h'(z) = \lim_{y \rightarrow \infty} f(z) - \lim_{y \rightarrow \infty} \psi(z) = 0 - 0 = 0$$

$h'(z)$ is indeed zero and $h(z) = c$, a constant. Then from (139),

$$\pi \cot \pi z = \frac{1}{z} + \sum_{n=-\infty}^{\infty} ' \left(\frac{1}{z-n} + \frac{1}{n} \right) + c$$

$$\text{For, } z = \frac{1}{2}$$

$$0 = 2 + \sum_1^{\infty} \left(\frac{2}{1-2k} + \frac{2}{1+2k} \right) + c$$

$$= 2 + 2 \left\{ \left(\frac{1}{-1} + \frac{1}{3} \right) + \left(-\frac{1}{3} + \frac{1}{5} \right) + \left(-\frac{1}{5} + \frac{1}{7} \right) + \dots \right\} + c$$

$$= 2 - 2 + c$$

$\Rightarrow c = 0$ i.e. $h(z) \equiv 0$. Finally we obtain

$$\pi \cot \pi z = \frac{1}{z} + \sum_{n=-\infty}^{\infty} \left\{ \frac{1}{z-n} + \frac{1}{n} \right\}$$

Now since the series on the r.h.s is uniformly convergent on any compact set not containing the points $z = 0, \pm 1, \pm 2, \dots$, rearrangement of the terms are permissible and hence

$$\pi \cot \pi z = \frac{1}{z} + \sum_{n=1}^{\infty} \frac{2z}{z^2 - n^2} \quad (141)$$

Remark : Here it is proved incidentally that

$$\pi^2 \operatorname{cosec}^2 \pi z = \sum_{n=-\infty}^{\infty} \frac{1}{(z-n)^2} \quad (142)$$

[see equation (140)]

We can now utilize the identity (141) to calculate easily some familiar sums. Here the l.h.s of (141) has the Laurent series expansion in the neighbourhood of $z = 0$.

$$\pi \cot \pi z = \frac{1}{z} - \frac{\pi^2 z}{3} - \frac{\pi^4 z^3}{45} - \frac{2\pi^6 z^5}{945} - \dots$$

Note that the series on the r.h.s of (141) converges uniformly near $z = 0$. By Th. 4.14 [14] it converges uniformly together with all derivatives. Again

$$\frac{2z}{z^2 - n^2} = -2 \left(\frac{z}{n^2} + \frac{z^3}{n^4} + \frac{z^5}{n^6} + \dots \right)$$

and we obtain easily,

$$\sum_{n \geq 1} \frac{1}{n^2} = \frac{\pi^2}{6}, \quad \sum_{n=1}^{\infty} \frac{1}{n^4} = \frac{\pi^4}{90}, \quad \sum_{n=1}^{\infty} \frac{1}{n^6} = \frac{\pi^6}{945} \quad (143)$$

Example 6. Prove that

$$\pi \tan \pi z = - \sum_{n=-\infty}^{\infty} \left[\frac{1}{z - \left(n + \frac{1}{2} \right)} + \frac{1}{n + \frac{1}{2}} \right]$$

$$[\text{or, equivalently, } \pi \tan \pi z = 2z \sum_{n=0}^{\infty} \left[\left(n + \frac{1}{2} \right)^2 - z^2 \right]^{-1}]$$

Solution : Here the given function $\pi \tan \pi z$ possesses simple poles at $z = \pm \frac{1}{2}, \pm \frac{3}{2}, \dots$ with residue -1 .

$$\text{Then, } \frac{-1}{z - \left(n + \frac{1}{2} \right)} = \frac{1}{\left(n + \frac{1}{2} \right) \left(1 - \frac{z}{n + \frac{1}{2}} \right)} = \frac{1}{n + \frac{1}{2}} \left[1 + \frac{z}{n + \frac{1}{2}} + \left(\frac{z}{n + \frac{1}{2}} \right)^2 + \dots \right]$$

and the series

$$\sum_{n=-\infty}^{\infty} \left[\frac{-1}{z - \left(n + \frac{1}{2} \right)} - \frac{1}{n + \frac{1}{2}} \right]$$

converges uniformly on any compact set not containing any of the poles of the given function. By Mittag-Leffler theorem,

$$\pi \tan \pi z = - \sum_{n=-\infty}^{\infty} \left[\frac{1}{z - \left(n + \frac{1}{2} \right)} + \frac{1}{n + \frac{1}{2}} \right] + h(z)$$

where $h(z)$ is an arbitrary entire function. Now proceeding as in example 5, we can have the desired result.

Example 7 : Establish that

$$\frac{1}{e^z - 1} = -\frac{1}{2} + \frac{1}{z} + \sum_{n=1}^{\infty} \frac{2z}{z^2 + 4n^2\pi^2}$$

Solution : We rewrite $1/e^z - 1$ as

$$\frac{1}{e^z - 1} = \frac{e^{-z/2}}{e^{z/2} - e^{-z/2}} = \frac{1}{2} \frac{e^{-z/2} - e^{z/2} + e^{z/2} + e^{-z/2}}{e^{z/2} - e^{-z/2}} = -\frac{1}{2} + \frac{1}{z} \coth \frac{z}{2}$$

$$\text{But } \coth \frac{z}{2} = \frac{\cosh \frac{z}{2}}{\sinh \frac{z}{2}} = \frac{i \cos\left(i \frac{z}{2}\right)}{\sin\left(i \frac{z}{2}\right)} = i \cot\left(i \frac{z}{2}\right)$$

Now utilising (141) we get the result.

6.15 Partial Fraction Expansion of Meromorphic Functions Using Residue theorem

Let us suppose f to be a meromorphic function whose only singularities are simple poles z_1, z_2, \dots with increasing moduli $0 < |z_1| \leq |z_2| \leq \dots$,

$\lim_{n \rightarrow \infty} z_n = \infty$ and $\text{Res}(f(z); z_n) = A_n$. Suppose there exists a sequence $\{C_n\}$ of simple closed contours such that

- (i) C_n does not contain any of the poles z_k
- (ii) each C_n lies inside C_{n+1}
- (iii) $\min_{z \in C_n} |z| = R_n \rightarrow +\infty$ as $n \rightarrow +\infty$
- (iv) length of C_n is $o(R_n)$
- (v) $\max_{z \in C_n} |f(z)| = o(R_n)$

$$\text{Then } f(z) = f(0) + \sum_{k=1}^{\infty} A_k \left(\frac{1}{z - z_k} + \frac{1}{z_k} \right) \quad (144)$$

The series (144) converges uniformly in any bounded domain not containing the poles of $f(z)$.

To prove the above result we consider the integral

$$I_n(z) = \frac{1}{2\pi i} \int_{C_n} \frac{zf(\zeta)}{\zeta(\zeta - z)} d\zeta \quad (145)$$

where $z \in \text{Int } C_n$ and $z \neq z_k$ ($k = 1, 2, \dots$)

Here the integrand in (145) possesses simple poles at $\zeta = 0$, $\zeta = z$ and $\zeta = z_k \in \text{Int } C_n$. Then using the Residue theorem, we find from (145) that

$$I_n(z) = \left[\frac{zf(\zeta)}{\zeta - z} \right]_{\zeta=0} + \left[\frac{zf(\zeta)}{\zeta} \right]_{\zeta=z} + \left[\frac{1}{\zeta(\zeta - z)} \right]_{\zeta=z_k} \text{Res}(f(\zeta); z_k)$$

$$= -f(0) + f(z) + \sum_{z_k \in \text{Int}C_n} \frac{zA_k}{z_k(z_k - z)}$$

Thus,

$$f(z) = f(0) + \sum_{z_k \in \text{Int}C_n} A_k \left(\frac{1}{z - z_k} + \frac{1}{z_k} \right) + \frac{1}{2\pi i} \int_{C_n} \frac{zf(\zeta)}{\zeta(\zeta - z)} d\zeta \quad (146)$$

We now show that $\lim_{n \rightarrow \infty} |I_n(z)| = 0$ for $|z| < R$.

$$|I_n(z)| \leq \frac{|z|}{2\pi} \int_{C_n} \frac{|f(\zeta)|}{|\zeta||\zeta - z|} |d\zeta| < \frac{R}{2\pi} \int_{C_n} \frac{|f(\zeta)|}{|\zeta||\zeta - R|} |d\zeta| \rightarrow 0$$

as $n \rightarrow \infty$ by the given conditions (iii), (iv) and (v).

Then (144) follows from (146) considering all the contours C_1, C_2, \dots etc.

Example 8 : If α_n are positive roots of the equation $\tan z = z$, show that

$$\frac{z \sin z}{\sin z - z \cos z} = \frac{3}{z} + \sum_{n=1}^{\infty} \frac{2z}{z^2 - \alpha_n^2}$$

where $\left(n - \frac{1}{2}\right)\pi < \alpha_n < \left(n + \frac{1}{2}\right)\pi$.

Solution : Given α_n are positive roots of $\tan z = z$, so $\pm \alpha_n$ are roots of $\sin z - z \cos z = 0$. To check whether the function $f(z)/g(z)$, where $f(z) = z \sin z$ and $g(z) = \sin z - z \cos z$, has any pole at $z = 0$ we notice that

$$\begin{array}{l|l} f'(z) = \sin z + z \cos z & g'(z) = z \sin z = f(z) \\ f''(z) = 2 \cos z - z \sin z & g''(z) = f'(z) \\ f'(0) = 0 \text{ but } f''(0) \neq 0 & f''(z) = g'''(z) \\ & \text{so, } g'(0) = g''(0) = 0 \text{ but } g'''(0) \neq 0 \end{array}$$

Thus origin is the double zero of $f(z)$ and triple zero of $g(z)$. As a result the given function f/g possesses a simple pole at $z = 0$. To find its residue at $z = 0$ we note that

$$\frac{f''(z)}{(z^2)''} = 1 \text{ and } \frac{g'''(z)}{(z^3)'''} = \frac{1}{3}$$

and so residue there is 3. Thus the function $F(z) = \frac{z \sin z}{\sin z - z \cos z} - \frac{3}{z}$ has the

simple poles at $z = \pm \alpha_n$ as its only singularities and $\text{Res}(F(z); \pm \alpha_n) = 1$ and $F(0) = 0$ since $F(z) = -F(-z)$.

Since $\left(n - \frac{1}{2}\right)\pi < \alpha_n < \left(n + \frac{1}{2}\right)\pi$, we consider the sequence of contours $\{C_n\}$, formed by the straight lines $x = \pm b_n, y = \pm b_n$ with $b_n = \left(n + \frac{1}{2}\right)\pi, n = 1, 2, \dots$,

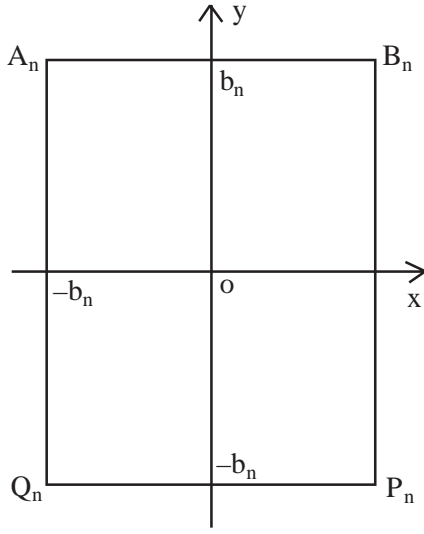

$A_n B_n P_n Q_n$ shown below :

We find that when $z \in B_n P_n, z = b_n + iy$, where $-b_n \leq y \leq b_n$.

Hence,

$$|\cot z| = \left| \frac{\cos\left\{\left(n + \frac{1}{2}\right)\pi + iy\right\}}{\sin\left\{\left(n + \frac{1}{2}\right)\pi + iy\right\}} \right|$$

$$= \left| \frac{\sin(iy)}{\cos(iy)} \right| = \left| \frac{e^y - e^{-y}}{e^y + e^{-y}} \right| \quad (147)$$

Same result holds when $z \in A_n Q_n$. Now when z lies on either of the lines $A_n B_n$ or $Q_n P_n, z = x \pm i\left(n + \frac{1}{2}\right)\pi$

$$|\cot z| = \left| \frac{\cos\left\{x \pm i\left(n + \frac{1}{2}\right)\pi\right\}}{\sin\left\{x \pm i\left(n + \frac{1}{2}\right)\pi\right\}} \right| \geq \frac{\sinh\left(n + \frac{1}{2}\right)\pi}{\cosh\left(n + \frac{1}{2}\right)\pi}$$

$$= \frac{1 - e^{-2(n+1)\pi}}{1 + e^{-2(n+1)\pi}} \geq \frac{e^\pi - 1}{e^\pi + 1} \quad (148)$$

The given function can be rewritten as

$$\frac{z \sin z}{\sin z - z \cos z} = \frac{1}{\frac{1}{z} - \cot z}$$

I. Bound on the sides A_nQ_n & B_nP_n of the square C_n : Using (147), we obtain

$$\left| \frac{1}{\frac{1}{z} - \cot z} \right| \leq \frac{1}{|\cot z| - \frac{1}{|z|}} = \frac{1}{\left| \frac{e^y - e^{-y}}{e^y + e^{-y}} \right| - \frac{1}{\sqrt{b_n^2 + y^2}}} \rightarrow 1 \text{ as } n \rightarrow \infty.$$

II. Bound on the sides A_nB_n & Q_nP_n of C_n : Here we apply (148) to achieve

$$\left| \frac{1}{\frac{1}{z} - \cot z} \right| \leq \frac{1}{|\cot z| - \frac{1}{|z|}} \leq \frac{1}{\frac{e^\pi - 1}{e^\pi + 1} - \frac{1}{\sqrt{b_n^2 + y^2}}} \rightarrow \frac{e^\pi + 1}{e^\pi - 1} \text{ as } n \rightarrow \infty.$$

Thus,

$$\left| \frac{z \sin z}{\sin z - z \cos z} \right| \leq \frac{e^\pi + 1}{e^\pi - 1}, \quad z \in C_n, \quad n = 1, 2, \dots$$

This shows that the function $F(z)$ is bounded on the sequence of contours $\{C_n\}$ and we can apply (144) to prove

$$\begin{aligned} \frac{z \sin z}{\sin z - z \cos z} &= \frac{3}{2} + \sum_{n=1}^{\infty} \left[\frac{1}{z - \alpha_n} + \frac{1}{\alpha_n} + \frac{1}{z + \alpha_n} - \frac{1}{\alpha_n} \right] \\ &= \frac{3}{2} + \sum_{n=1}^{\infty} \frac{2z}{z^2 - \alpha_n^2} \end{aligned}$$

Exercises

1. Obtain partial fraction expansion of cosec z .
2. Prove that

$$\sec z = \sum_{n=1}^{\infty} (-1)^n \frac{(2n-1)\pi}{z^2 - \left(n - \frac{1}{2}\right)^2 \pi^2}$$

3. Show that

$$\tan z = - \sum_{n=1}^{\infty} \frac{2z}{z^2 - \left(n - \frac{1}{2}\right)^2 \pi^2}$$

and hence deduce

$$1 + \frac{1}{3^2} + \frac{1}{5^2} + \dots = \frac{\pi^2}{8}$$

6.16 The Gamma Function

The gamma function $\Gamma(z)$ was introduced by Swedish Mathematician L. Euler (1707-1783), in 1729 while he was seeking for a function of a real variable x which is continuous for positive x and reduces to $x!$ when x is a positive integer. Gamma function is widely used in the fields of probability and statistics, as well as combinatorics.

Gamma function $\Gamma(z)$ can be introduced in either of the ways :

- (i) in terms of infinite product
- (ii) in the form of infinite integral
- (iii) in limit formula

We establish the form (i) first considering the fact that it possesses simple poles at $z = 0, -1, -2, \dots$ and nowhere vanishes in the entire plane and satisfies

$$z\Gamma(z) = \Gamma(z + 1), \Gamma(1) = 1 \quad (149)$$

To construct $\Gamma(z)$ we claim that $f(z) = 1/\Gamma(z)$ is entire with simple zeros at $z = -n$ ($n = 0, 1, 2, \dots$).

Again we know that $k = 1$ is the largest non-negative integer for which

$$\sum_{n=1}^{\infty} \frac{1}{n^k}$$

diverges. Then utilizing the Weierstrass Factorization theorem $f(z)$ can be represented as

$$f(z) = ze^{g(z)} \prod_{n=1}^{\infty} \left(1 + \frac{z}{n}\right) e^{-\frac{z}{n}}$$

where $g(z)$ is an entire function, so that gamma function will be of the form

$$\Gamma(z) = e^{-g(z)} \frac{1}{z \prod_{n=1}^{\infty} \left(1 + \frac{z}{n}\right) e^{-z/n}} \quad (150)$$

Now we find $g(z)$ so that (149) hold. We write (150) in the form

$$\begin{aligned}
\Gamma(z) &= \lim_{n \rightarrow \infty} \frac{e^{-g(z)}}{z \prod_1^n \left(1 + \frac{z}{m}\right) e^{\frac{-z}{m}}} \\
&= \lim_{n \rightarrow \infty} \frac{n! \exp\left[-g(z) + \sum_1^n \frac{z}{m}\right]}{z(z+1)\dots(z+n)} = \lim_{n \rightarrow \infty} \Gamma_n(z), \text{ say}
\end{aligned} \tag{151}$$

$$\begin{aligned}
\frac{z\Gamma_n(z)}{\Gamma_n(z+1)} &= \frac{n! z \exp\left[-g(z) + \sum_1^n \frac{z}{m}\right]}{z(z+1)\dots(z+n)} \frac{(z+1)(z+2)\dots(z+n+1)}{n! \exp\left[-g(z+1) + \sum_1^n \frac{z+1}{m}\right]} \\
&= (z+n+1) \exp\left[g(z+1) - g(z) - \sum_1^n \frac{1}{m}\right] \\
&= \left(1 + \frac{z+1}{n}\right) n \exp\left[g(z+1) - g(z) - \sum_1^n \frac{1}{m}\right] \\
&= \left(1 + \frac{z+1}{n}\right) \exp\left[g(z+1) - g(z) - \sum_1^n \frac{1}{m} + \log n\right]
\end{aligned}$$

Now from the relation $\frac{z\Gamma(z)}{\Gamma(z+1)} = \lim_{n \rightarrow \infty} \frac{z\Gamma_n(z)}{\Gamma_n(z+1)}$, we find that

$$\begin{aligned}
\frac{z\Gamma(z)}{\Gamma(z+1)} &= \lim_{n \rightarrow \infty} \left(1 + \frac{z+1}{n}\right) \exp\left[g(z+1) - g(z) - \sum_1^n \frac{1}{m} + \log n\right] \\
&= \exp[g(z+1) - g(z) - \gamma]
\end{aligned}$$

where
$$\gamma = \lim_{n \rightarrow \infty} \left(\sum_1^n \frac{1}{m} - \log n\right) = 0.57722$$
 (152)

is known as the Euler's constant.

Thus in order that the conditions in (149) to hold, we should have

$$g(z+1) - g(z) = \gamma + 2k\pi i \quad (k \equiv \text{integer}) \tag{153}$$

and

$$1 = \Gamma(1) = \lim_{n \rightarrow \infty} \Gamma_n(1) = \lim_{n \rightarrow \infty} \frac{e^{-g(1) + \sum_1^n \frac{z}{m} - \log n}}{1 + \frac{1}{n}} = e^{-g(1) + \gamma}$$

so that $g(1) = \gamma + 2j\pi i$ ($j \equiv \text{integer}$) (154)

The simplest entire function satisfying (154) is given by

$$g(z) = \gamma z$$

Finally from (150),

$$\Gamma(z) = \frac{e^{-\gamma z}}{z} \prod_1^{\infty} \left(1 + \frac{z}{n}\right)^{-1} e^{z/n} \quad (155)$$

Gauss's Formula

From (151) we have the representation

$$\begin{aligned} \Gamma(z) &= \lim_{n \rightarrow \infty} \frac{n! \exp\left[\left(\sum_1^n \frac{1}{m} - \gamma\right)z\right]}{z(z+1)\dots(z+n)} \\ &= \lim_{n \rightarrow \infty} \frac{n! \exp\left[\left\{\left(\sum_1^n \frac{1}{m} - \gamma - \log n\right) + \log n\right\}z\right]}{z(z+1)\dots(z+n)} \\ &= \lim_{n \rightarrow \infty} \frac{n! n^z}{z(z+1)\dots(z+n)}, \text{ since } \lim_{n \rightarrow \infty} \left(\sum_1^n \frac{1}{m} - \log n - \gamma\right) = 0 \end{aligned} \quad (156)$$

The above expression for $\Gamma(z)$, $z \neq 0, -1, -2, \dots$ is termed as Gauss's formula, though it was first derived by Euler.

In many places it is known as Euler's limit formula.

Example 9 : Let

$$\Gamma(z, n) = \frac{n! n^z}{z(z+1)\dots(z+n)}$$

Prove that

$$\Gamma(z, n) = \frac{n^z \Gamma(n+1) \Gamma(z)}{\Gamma(n+z+1)}$$

and hence deduce that

$$\frac{n^z \Gamma(n)}{\Gamma(n+z)} \rightarrow 1 \text{ as } n \rightarrow \infty$$

Solution :

$$\Gamma(n+z+1) = z(z+1)(z+2)\dots(z+n) \Gamma(z)$$

$$\text{so, } \frac{n^z \Gamma(n+1) \Gamma(z)}{\Gamma(n+z+1)} = \frac{n^z \Gamma(n+1)}{z(z+1)(z+2)\dots(z+n)} = \frac{n! n^z}{z(z+1)(z+2)\dots(z+n)} = \Gamma(z, n)$$

Now,

$$\frac{n^z \Gamma(n)}{\Gamma(n+z)} = \frac{(n+z) \Gamma(z, n)}{n \Gamma(z)}$$

$$\lim_{n \rightarrow \infty} \frac{n^z \Gamma(n)}{\Gamma(n+z)} = \lim_{n \rightarrow \infty} \left(1 + \frac{z}{n}\right) \frac{\lim_{n \rightarrow \infty} \Gamma(z, n)}{\Gamma(z)} = 1 \text{ by Gauss's formula.}$$

In the expression (155) for $\Gamma(z)$ the infinite product is uniformly convergent on every compact subset of $\mathcal{C} - \{0, -1, \dots\}$. So calculating $\Gamma'(z)/\Gamma(z)$ we find that

$$\frac{\Gamma'(z)}{\Gamma(z)} = -\gamma - \frac{1}{z} + \sum_{n=1}^{\infty} \left(-\frac{1}{n+z} + \frac{1}{n} \right)$$

This function $\frac{\Gamma'(z)}{\Gamma(z)}$ is denoted by $\psi(z)$ and named as Gaussian psi function and it is

seen from its expression that ψ is meromorphic in \mathcal{C} with simple poles at $z = 0, -1, -2, \dots$ and $\text{Res}(\psi; -n) = -1$ for $n = 0, 1, 2, \dots$

Example 10 : Show that

$$(i) \psi(1) = -\gamma$$

$$(ii) \psi(z+1) - \psi(z) = \frac{1}{z}$$

$$(iii) \psi(z) - \psi(1-z) = -\pi \cot \pi z.$$

Solution :

$$(i) \quad \psi(z) = -\gamma - \frac{1}{z} + \sum_{n=1}^{\infty} \left(-\frac{1}{n+z} + \frac{1}{n} \right)$$

so,

$$\begin{aligned}\psi(1) &= -\gamma - 1 + \sum_{n=1}^{\infty} \left(-\frac{1}{n+1} + \frac{1}{n} \right) \\ &= -\gamma - 1 + \left(1 - \frac{1}{2} + \frac{1}{2} - \frac{1}{3} + \frac{1}{3} - \dots \right) \\ &= -\gamma.\end{aligned}$$

(ii) $\psi(z+1) - \psi(z) = -\gamma - \frac{1}{z+1} + \sum_{n=1}^{\infty} \left(-\frac{1}{n+z+1} + \frac{1}{n} \right) - \sum_{n=1}^{\infty} \left(-\frac{1}{n+z} + \frac{1}{n} \right) + \gamma + \frac{1}{z}$

$$\begin{aligned}&= \frac{1}{z} - \frac{1}{z+1} + \sum_{n=1}^{\infty} \left(\frac{1}{n+z} - \frac{1}{n+z+1} \right) \\ &= \frac{1}{z} - \frac{1}{z+1} + \left(\frac{1}{z+1} - \frac{1}{z+2} + \frac{1}{z+2} - \frac{1}{z+3} + \dots \right) \\ &= \frac{1}{z}.\end{aligned}$$

(iii) $\psi(z) - \psi(1-z) = -\frac{1}{z} + \frac{1}{1-z} + \sum_1^{\infty} \left(\frac{1}{n} - \frac{1}{n+z} \right) - \sum_1^{\infty} \left(\frac{1}{n} - \frac{1}{n+1-z} \right)$

$$\begin{aligned}&= -\frac{1}{z} - \frac{1}{z-1} + \sum_1^{\infty} \left(\frac{1}{n+1-z} - \frac{1}{n+z} \right) \\ &= -\frac{1}{z} - \frac{1}{z-1} - \frac{1}{z+1} - \frac{1}{z-2} - \frac{1}{z+2} - \dots \\ &= -\frac{1}{z} - \left(\frac{1}{z-1} + \frac{1}{z+1} \right) - \left(\frac{1}{z-2} + \frac{1}{z+2} \right) - \dots \\ &= -\frac{1}{z} - \sum_1^{\infty} \frac{2z}{z^2 - n^2} = -\pi \cot \pi z, \text{ by (141)}\end{aligned}$$

6.17 A Few Properties of $\Gamma(z)$

We have $\frac{1}{\Gamma(z)} = e^{\gamma z} z \prod_1^{\infty} \left(1 + \frac{z}{n} \right) e^{-z/n}$

Hence, $\frac{1}{\Gamma(z)\Gamma(-z)} = -z^2 \prod_1^{\infty} \left(1 - \frac{z^2}{n^2} \right)$

$$= -\frac{z}{\pi} \pi z \prod_1^{\infty} \left(1 - \frac{z^2}{n^2}\right)$$

$$= -\frac{z}{\pi} \sin \pi z$$

or,
$$\frac{1}{\Gamma(z)[-z\Gamma(-z)]} = \frac{\sin \pi z}{\pi}$$

i.e.
$$\frac{1}{\Gamma(z)\Gamma(1-z)} = \frac{\sin \pi z}{\pi}, \quad [\text{using } z\Gamma(z) = \Gamma(z+1) \text{ i.e., } -z\Gamma(-z) = \Gamma(1-z)]$$
 (157)

In particular, $\left[\Gamma\left(\frac{1}{2}\right)\right]^2 = \pi$ and $\Gamma\left(\frac{1}{2}\right) = \sqrt{\pi}$ (minus sign is excluded since $\Gamma\left(\frac{1}{2}\right)$ is positive by (155)). Likewise using

$$\Gamma(z+1) = z\Gamma(z)$$

we find

$$\Gamma\left(\frac{3}{2}\right) = \frac{1}{2}\Gamma\left(\frac{1}{2}\right) = \frac{1}{2}\sqrt{\pi}$$

$$\Gamma\left(\frac{5}{2}\right) = \frac{3}{2}\Gamma\left(\frac{3}{2}\right) = \frac{3}{2} \cdot \frac{1}{2}\sqrt{\pi}$$

$$\Gamma\left(\frac{7}{2}\right) = \frac{5}{2}\Gamma\left(\frac{5}{2}\right) = \frac{5}{2} \cdot \frac{3}{2} \cdot \frac{1}{2}\sqrt{\pi}$$

and in general

$$\Gamma\left(n + \frac{1}{2}\right) = \frac{1 \cdot 3 \cdot \dots \cdot (2n-1)}{2^n} \sqrt{\pi}, \quad (n = 1, 2, \dots)$$

i.e.
$$\Gamma\left(n + \frac{1}{2}\right) / \sqrt{\pi} = \frac{(2n)!}{n!(2)^{2n}}$$
 (158)

If n is a positive integer repeated use of (149) produce

$$\Gamma(n+1) = n!$$

The Γ -function can therefore be considered as an extension of the factorial function to the complex plane.

Legendre's Duplication Formula

Let us consider the Gauss's formula

$$\Gamma(z) = \lim_{n \rightarrow \infty} \frac{n! n^z}{z(z+1)\dots(z+n)} = \lim_{n \rightarrow \infty} \Gamma(z, n), \text{ say}$$

Then,

$$\begin{aligned} \Gamma(2z, 2n) &= \frac{(2n)!(2n)^{2z}}{2z(2z+1)\dots(2z+n)\dots(2n+2z)} \\ &= \frac{2^{2n} n! \Gamma\left(n + \frac{1}{2}\right) (\sqrt{\pi})^{-1} (2n)^{2z}}{2z(2z+1)(2z+2)\dots(2z+2n)} \quad [\text{Replacing } (2n)! \text{ by (158)}] \\ &= \frac{2^{2z-1} n! (n)^{2z} \Gamma\left(n + \frac{1}{2}\right)}{\sqrt{\pi} z(z+1)(z+2)\dots(z+n) \left(z + \frac{1}{2}\right) \left(z + \frac{3}{2}\right) \dots \left(z + n - \frac{1}{2}\right)} \\ &= \frac{2^{2z-1}}{\sqrt{\pi}} \Gamma(z, n) \Gamma\left(n + \frac{1}{2}\right) \frac{1}{\left(z + \frac{1}{2}\right) \left(z + \frac{3}{2}\right) \dots \left(z + n - \frac{1}{2}\right)} \\ &= \frac{2^{2z-1}}{\sqrt{\pi}} \Gamma(z, n) \Gamma\left(n + \frac{1}{2}\right) \frac{\Gamma\left(z + \frac{1}{2}, n\right) z + \frac{1}{2} + n}{n^{1/2} \Gamma(n)} \frac{1}{n} \end{aligned}$$

$$\text{and } \Gamma(2z) = \lim_{n \rightarrow \infty} \Gamma(2z, 2n) = \frac{2^{2z-1}}{\sqrt{\pi}} \Gamma(z) \Gamma\left(z + \frac{1}{2}\right) \lim_{n \rightarrow \infty} \left[\frac{\Gamma\left(n + \frac{1}{2}\right) z + \frac{1}{2} + n}{n^{1/2} \Gamma(n)} \frac{1}{n} \right]$$

$$= \frac{2^{2z-1}}{\sqrt{\pi}} \Gamma(z) \Gamma\left(z + \frac{1}{2}\right) \quad [\text{using example 9}]$$

So that

$$\sqrt{\pi} \Gamma(2z) = 2^{2z-1} \Gamma(z) \Gamma\left(z + \frac{1}{2}\right) \quad (159)$$

This is known as Legendre's duplication formula.

Residue of $\Gamma(z)$ at its poles

$\Gamma(z)$ is analytic throughout the complex plane except at its only singularities which are simple poles situated at $z = 0, -1, -2, \dots$. That is $\Gamma(z)$ is analytic in the right half of the complex plane $\text{Re } z > 0$. Using the fact that $z\Gamma(z) = \Gamma(z + 1)$, we have

$\Gamma(z + n + 1) = (z + n)(z + n - 1)(z + n - 2)\dots(z + 1)z\Gamma(z)$, $n \equiv$ positive integer and

$$\Gamma(z) = \frac{\Gamma(z + n + 1)}{z(z + 1)\dots(z + n - 1)(z + n)}$$

$$\begin{aligned} \text{Res } (\Gamma(z); -n) &= \lim_{z \rightarrow -n} (z + n)\Gamma(z) \\ &= \lim_{z \rightarrow -n} \frac{\Gamma(z + n + 1)}{z(z + 1)\dots(z + n - 1)} \\ &= \frac{(-1)^n}{n!}, \quad n = 0, 1, 2, \dots \end{aligned}$$

Integral representation of $\Gamma(z)$

Theorem : Prove that

$$\Gamma(z) = \int_0^{\infty} e^{-t} t^{z-1} dt \quad \text{for } \text{Re } z > 0.$$

Proof. Let

$$F_n(z) = \frac{n! n^z}{z(z + 1)\dots(z + n)}$$

We prove the theorem in the following two steps :

$$(i) \quad F_n(z) = \int_0^n \left(1 - \frac{t}{n}\right)^n t^{z-1} dt$$

$$(ii) \quad \lim_{n \rightarrow \infty} \int_0^n \left(1 - \frac{t}{n}\right)^n t^{z-1} dt = \int_0^{\infty} e^{-t} t^{z-1} dt$$

To establish (i) we change the variable t to ns in

$$\int_0^n \left(1 - \frac{t}{n}\right)^n t^{z-1} dt$$

to obtain

$$\int_0^n \left(1 - \frac{t}{n}\right)^n t^{z-1} dt = n^z \int_0^1 (1 - s)^n s^{z-1} ds$$

Now integrating by parts we find the right hand side is equal to

$$\begin{aligned}
& n^z \left[\frac{1}{z} s^z (1-s)^n \Big|_0^1 + \frac{n}{z} \int_0^1 (1-s)^{n-1} s^z ds \right] \\
&= n^z \frac{n}{z} \int_0^1 (1-s)^{n-1} s^z ds \\
&= n^z \frac{n \cdot (n-1) \dots 1}{z(z+1) \dots (z+n-1)} \int_0^1 s^{z+n-1} ds \quad [\text{Integrating by parts } (n-1) \text{ times}] \\
&= \frac{n! n^z}{z(z+1) \dots (z+n)} = F_n(z)
\end{aligned}$$

Now to prove (ii) we show that

$$\lim_{n \rightarrow \infty} \int_0^n \left[e^{-t} - \left(1 - \frac{t}{n}\right)^n \right] t^{z-1} dt = 0, \quad \text{Re } z > 0 \quad (161)$$

For this, note that

$$1 + \frac{t}{n} \leq e^{\frac{t}{n}} \leq \frac{1}{1 - \frac{t}{n}} \quad \text{for } |t| < n \quad (162)$$

$$\text{Then,} \quad \left(1 + \frac{t}{n}\right)^n \leq e^t \quad \text{and} \quad \left(1 - \frac{t}{n}\right)^n \leq e^{-t};$$

Consequently,

$$\begin{aligned}
0 &\leq e^{-t} - \left(1 - \frac{t}{n}\right)^n = e^{-t} \left[1 - e^t \left(1 - \frac{t}{n}\right)^n \right] \leq e^{-t} \left[1 - \left(1 - \frac{t^2}{n^2}\right)^n \right] \\
&= e^{-t} \frac{t^2}{n^2} \left[1 + \left(1 - \frac{t^2}{n^2}\right) + \dots + \left(1 - \frac{t^2}{n^2}\right)^{n-1} \right] \leq e^{-t} \frac{t^2}{n}.
\end{aligned}$$

Therefore,

$$\left| \int_0^n \left[e^{-t} - \left(1 - \frac{t}{n}\right)^n \right] t^{z-1} dt \right| < \frac{1}{n} \int_0^n e^{-t} t^{\text{Re } z+1} dt$$

which approaches zero as $n \rightarrow \infty$ because the integral on the right converges. This completes the proof of (ii). Finally combining the results (i) and (ii) with the Gauss's formula (156) we get

$$\Gamma(z) = \lim_{n \rightarrow \infty} F_n(z) = \lim_{n \rightarrow \infty} \int_0^n \left(1 - \frac{t}{n}\right)^n t^{z-1} dt = \int_0^\infty e^{-t} t^{z-1} dt$$

References

1. M. J. Ablowitz and A. S. Fokas, Complex variables, 2nd edition, Cambridge University Press, 2003.
2. L. V. Ahlfors, Complex analysis, 2nd edition, McGraw-Hill, 1979.
3. R. Buck, Advanced Calculus.
4. J. B. Conway, Functions of one complex variable, Springer International Student Edition, 1973.
5. E. T. Copson, An introduction to the theory of functions of a complex variable, Clarendon Press, Oxford, 1935.
6. J. W. Dettman, Applied complex variables, Macmillan, New York, 1965.
7. J. G. Krzyz, Problems in complex variable theory. American Elsevier Publishing Company, INC, New York, 1971.
8. W. K. Hayman, Multivalued functions, Cambridge University Press, 1958.
9., Meromorphic functions, Clarendon Press, Oxford, 1964.
10. J. E. Marsden, Basic Complex analysis, W. H. Freeman and Company, Sanfrancisco, 1973.
11. A. I. Markushevich, Theory of functions of a complex variable-3 vols Prentice Hall, Engle Wood, Cliffs, N. J. 1965-67.
12. Z. Nehari, Conformal Mapping. McGraw-Hill, New York, 1952.
13. W. Rudin, Real and complex Analysis, Third Edition, McGraw-Hill, 1987.
14. P. K. Sengupta, Complex Analysis, Netaji Subhas Open University, 2003.
15. Y. V. Sidorov, M. V. Fedoryuk and M. I. Shabunin, Lectures on the theory of functions of a complex variable, Mir Publishers, Moscow, 1985.
16. E. C. Titchmarsh, The theory of functions, Oxford University Press, 1964.

